



Automation and Control Essentials Catalog 2022

Everything you need for your control panels

se.com

Life Is On

Schneider
Electric



The Essentials for your control panels

You will find all the essentials you need for high-quality control panels in this catalog. Choose the right products to set up your equipment with ease, complete your work faster, and give your business a boost.

New 2022 product highlights



- > Harmony XB4/XB5 monitoring contact
- > Harmony ZBRT wireless batteryless contact block
- > Harmony XAP metal control station
- > Antimicrobial Harmony version
- > Harmony STM6 Box
- > Tesys Deca
- > Tesys Giga
- > New Power Tag
- > New Power Gateway
- > Motor Control Management Building
- > Ecostruxure Device Connector Bluefer
- > Altivar ATV320
- > Harmony SSD Solid State Relays
- > Uninterruptible Power Supply
- > Preventa XPSU safety switches
- > Universal enclosures configurator: Proclima web / Spatial Configurator
- > XUM Photoelectric miniature

Discover our Certified Safety Chain solutions

“Safety Chain Solutions” is a set of documentation that, through example, will provide you with most of the information you need to retrofit existing machine designs, or to integrate into new ones, the new Functional Safety Requirements as specified by EN/IEC 62061, EN/ISO 13849-1 and other specific standards related to functional safety and its implementation.

- Complete User Guide explaining;
 - Technical concept
 - Wiring plan
 - Calculation explanation
 - Sistema project file and TÜV certification
 - Ready to use documentation
<https://www.se.com/ww/en/download/document/DIA3ED2140902EN/>



EcoStruxure™ Motor Control Configurator

Motors are critical assets, and also big consumers of electrical energy using on average 60% of the electrical energy in industrial businesses.

A robust, tested and validated architectural approach to your motor management unleashes more safety and performance for your motors, enabling advanced asset management and energy efficiency. With an extensive offer portfolio, competencies and know-how, Schneider Electric can help you build a sustainable motor integration solution across the electrical system and the industrial processes.

A dedicated application for calculations and motor management solution selection for high powered LV and MV motor applications. Save time for equipment sizing while focusing on the essentials: how to start, protect and manage power quality and monitor your motor and application.



Start using now: EcoStruxure™ Motor Control Configurator
<https://www.se.com/ww/en/work/products/industrial-automation-control/tools/motor-control-configurator.jsp>

Learn more about our motor control applications, visit www.se.com/motormanagement



Relays: complete offer

Schneider Electric has the most complete offer from Control Relays to Timer Relays, Electromechanical and Solid State Relay. Enhance operational efficiency and optimize equipment availability with Harmony, our widest range of relays. Harmony relays are designed, manufactured and tested to meet your needs for both wired logic functions and PLC interfaces.

Schneider Electric offers Harmony relays to meet your wide range of applications. Our relays include conventional Electromechanical Relays, Solid State Relays, Control Relays, Timing Relays, and NFC Control & Timing Relays.

Comprehensive: A wide range to address your standard or performance needs

Reliable: High product performance to ensure machine and system availability

Time saving: Innovative features to improve user experience.

Embedded test button to ease troubleshooting and commissioning

A simplicity-driven design: To deliver maximum ease-of-use throughout the life cycle

Green: Compliant to international certifications, and environment friendly



Harmony Control Relays



Harmony Solid State Relays



Harmony Timer Relays



Harmony Electromechanical Relays

Discover relays offer

<https://www.se.com/ww/en/product-subcategory/2810-automation-relays/>

Take advantage of learning opportunities

Gain access to our diverse learning resources, providing practical knowledge and tips, and open new opportunities for your business.

Explore the manuals, tutorials, “how to” videos, and online courses to broaden your skills and make your daily work faster and simpler.

<https://www.youtube.com/channel/UCnpqjEw2RHDBNVGDe8pi7tw>

- 1 Go to product selectors and configurators
- 2 Download the digital catalog
- 3 Explore our learning resources



Get all the products
you need from a distributor
close to you

General contents

01	Harmony pushbuttons, switches, pilot lights and signaling devices.....	6
02	Harmony Human Machine Interfaces (HMI) - Basic panels.....	22
03	TeSys motor management, distribution system protection, power metering and control.....	26
04	Altivar soft starters and Altivar variable speed drives.....	38
05	Harmony interface, measurement and control relays.....	44
06	Modicon PLC, power supply and transformer, Uninterruptible Power Supply	52
07	Harmony safety modules and Modicon safety controllers.....	58
08	Universal enclosures.....	64
09	Telemecanique Sensors - Detection components	70



01. Harmony pushbuttons, switches, pilot lights, and signaling devices

Harmony XVU and XVSV signaling solutions



Harmony XVU components for Ø 60 modular tower lights

1 IP65 light modules (for association)										
Voltage		24 V								
LED unit type		High brightness							Pulse signal	
Color		● Green	● Red	● Orange	● Blue	○ White	● Yellow	Multi-color	Multi-color	
Reference	Steady	XVUC23	XVUC24	XVUC25	XVUC26	XVUC27	XVUC28	XVUC29	XVUC29P	
	Blinking	XVUC43	XVUC44	XVUC45	XVUC46	XVUC47	XVUC48	–	–	
	High flashing	XVUC63	XVUC64	XVUC65	XVUC66	XVUC67	XVUC68	–	–	
2 IP54 audible units (for association)										
Voltage		24 V								
Unit type		Buzzer		Sound	Sound with pulse signal					
Color		○ Silver		● Dark gray						
Reference		XVUC9SQ	XVUC9S	XVUC9V	XVUC9VP					
3 IP65 body units with top cover (for association)										
Voltage		24 VAC/VDC			100...240 VAC					
Color		○ Silver		● Dark gray						
Type		–		NPN	PNP					
Reference		XVUC21BQ	XVUC21B	XVUC21M	XVUC21MP					
Mounting bases for horizontal support (for association)										
Base type		Fixing plates With fixed length aluminum pole 100 mm/3.937 in 400 mm/15.748 in 800 mm/31.496 in				With height adjustment aluminum pole (1)		Direct fixing plates		
Color		○ Silver		● Dark gray				○ Silver		● Dark gray
Reference		XVUZ02Q	XVUZ02	XVUZ400	XVUZ800	XVUZ05 (2)	XVUZ01Q	XVUZ01 (3)		
		–	–	–	–	–	–	XVUZ03 (4)		
		–	–	–	–	–	–	XVUZ04 (5)		
6 Mounting bases for vertical support (for association)										
Base type		Fixing plates for mounting on vertical support (aluminum pole + metal bracket - IP42)					Fixing plates for vertical support			
		100 mm		250 mm		400 mm		100 mm		
Color		● Dark gray		● Dark gray		● Dark gray		● Dark gray		
Reference		XVUZ100T		XVUZ250T		XVUZ400T		XVUZ12 (7)		
Accessories (for association)										
Unit type		Body extender				Flexible mounting unit for use on horizontal or vertical support, IP55		1/2" NPT conduit adaptor for customer supplied tubing		
Color		● Dark gray		○ Silver		● Dark gray		● Dark gray		
Reference		XVUC020		XVUC020Q		XVUZ06 (6)		XVUZ00		

(1) Pole height adjustable from 210 to 385 mm (2) For use with DC body unit only
 (3) 3-pin mounting (4) 2-pin mounting (5) 4-pin mounting (6) Only compatible with direct fixing plates
 (7) Compatible with all mounting bases for horizontal support except XVUZ01, XVUZ01Q, XVUZ02, and XVUZ04.

Harmony XVSV complete units

XVSV sound modules									
Size	DIN 72				DIN 96				
Voltage	12 - 24 VDC				12 - 24 VDC		100 - 230 VAC		
Color	● Dark gray		○ White		● Dark gray		○ White	● Dark gray	○ White
Wiring	NPN	PNP	NPN	NPN	PNP	NPN	NPN	NPN	
Reference	XVSV7BBN	XVSV7BBP	XVSV7BWN	XVSV9BBN	XVSV9BBP	XVSV9BWN	XVSV9MBN	XVSV9MWN	
Wall mounting plate (option)	XVSV016								

1



Illuminated units for incandescent bulbs or LEDs

Illuminated units with steady light signaling							
Color	Green	Red	Orange	Blue	White	Yellow	
Light source (to be ordered separately)	Incandescent bulb 7 W max. or LED	XVBC33	XVBC34	XVBC35	XVBC36	XVBC37	XVBC38
Illuminated units with integral flashing light signaling							
Color	Green	Red	Orange	Blue	White	Yellow	
Light source (to be ordered separately)	Incandescent bulb 7 W max., 24 V ~, 24...48 V ~ or LED	XVBC4B3	XVBC4B4	XVBC4B5	XVBC4B6	XVBC4B7	XVBC4B8
	Incandescent bulb 7 W max., 24 V ~, 48...230 V ~ or LED	XVBC4M3	XVBC4M4	XVBC4M5	XVBC4M6	XVBC4M7	XVBC4M8

Illuminated units with integral LED



Light source voltage 24 V ~							
Color	Green	Red	Orange	Blue	White	Yellow	
Reference	Steady	XVBC2B3	XVBC2B4	XVBC2B5	XVBC2B6	XVBC2B7	XVBC2B8
	Flashing	XVBC5B3	XVBC5B4	XVBC5B5	XVBC5B6	XVBC5B7	XVBC5B8
Light source voltage 120 V ~							
Color	Green	Red	Orange	Blue	White	Yellow	
Reference	Steady	XVBC2G3	XVBC2G4	XVBC2G5	XVBC2G6	XVBC2G7	XVBC2G8
	Flashing	XVBC5G3	XVBC5G4	XVBC5G5	–	–	–
Light source voltage 230 V ~							
Color	Green	Red	Orange	Blue	White	Yellow	
Reference	Steady	XVBC2M3	XVBC2M4	XVBC2M5	XVBC2M6	XVBC2M7	XVBC2M8
	Flashing	XVBC5M3	XVBC5M4	XVBC5M5	XVBC5M6	XVBC5M7	XVBC5M8

Illuminated units with integral “flash” discharge tube



Light source voltage 24 V ~							
Color	Green	Red	Orange	Blue	White	Yellow	
Reference	5 Joule “flash” discharge tube	XVBC6B3	XVBC6B4	XVBC6B5	XVBC6B6	XVBC6B7	XVBC6B8
	10 Joule “flash” discharge tube	XVBC8B3	XVBC8B4	XVBC8B5	XVBC8B6	XVBC8B7	XVBC8B8
Light source voltage 120 V ~							
Color	Green	Red	Orange	Blue	White	Yellow	
Reference	5 Joule “flash” discharge tube	–	XVBC6G4	XVBC6G5	–	XVBC6G8	
	10 Joule “flash” discharge tube	XVBC8G3	XVBC8G4	XVBC8G5	XVBC8G6	XVBC8G8	
Light source voltage 230 V ~							
Color	Green	Red	Orange	Blue	White	Yellow	
Reference	5 Joule “flash” discharge tube	XVBC6M3	XVBC6M4	XVBC6M5	XVBC6M6	XVBC6M7	XVBC6M8
	10 Joule “flash” discharge tube	–	XVBC8M4	XVBC8M5	XVBC8M6	XVBC8M7	XVBC8M8

Harmony XVB signaling solutions and Harmony XVR3 beacon lights



1 Audible units			
Unit type	Buzzer, 90 dB at 1 m		
Unit description	Adjustable: 70 or 90 dB, continuous or intermittent		
Voltage	12...48 V DC and AC	120...230 V ~	
Reference	XVBC9B	XVBC9M	

2 Base units (for direct or tube fixing)				
Unit type	Base unit + cover with bottom or side cable entry	Base unit only with bottom or side cable entry	Base unit + cover with side cable entry	Base unit + cover with bottom entry, pre-cabled (length 1 m), and equipped with M12 end connector
Application	Use with banks without discharge tube unit (order separately)	Use with banks with discharge tube unit (order separately)	All types of banks. Can be used with AS-interface connection	
Reference	XVBC21	XVBC07	XVBC21A	XVBC21B

Accessories specific to XVBC indicator banks

Unit type	Cover only ³	Fixing plate for use on horizontal support	Fixing plate for use on vertical support
Material	Plastic	Plastic	Zamak
Application	XVBC2, XVBC3, XVBC4, XVBC5, and XVBC9	Ø 25 mm aluminum support tube	Base unit (direct mounting), fixing plate XVBC21 or fixing bases XVBC0
Reference	XVBC081	XVBZ01	XVBC12 ⁴

Unit type	Fixing bases comprising Ø 25 mm aluminum support tube glued into a black plastic fixing plate					
Color	Black aluminum	Aluminum	Black aluminum	Aluminum	Black aluminum	Aluminum
Height under base unit (mm)	80			380		780
Reference	XVBZ02	XVBZ02A	XVBZ03	XVBZ03A	XVBZ04	XVBZ04A

Unit type	Support tube concealment cover		Adapter for side entry through base unit		
Material	ABS	ABS	ABS		
Application	Support tubes XVBC202, XVBC202A	Support tubes XVBC203, XVBC203A	13P cable gland		
Reference	XVBC020	XVBC030	XVBC14		

Unit type	Incandescent bulbs BA 15d base fitting				
Voltage	12 V	24 V	48 V	120 V	230 V
Power	7 W	6.5 W	6 W	7 W	7 W
Reference	DL1BEJ	DL1BEB	DL1BEE	DL1BEG	DL1BEM

Unit type	LEDs BA 15d base fitting				
Color	● Green	● Red	● Orange	● Blue	● Yellow
Voltage	24 V ~				
Reference	DL1BDB3	DL1BDB4	DL1BDB5	DL1BDB6	DL1BDB8

Harmony XVR3 pre-cabled motorless rotating/flashing beacons



6 Beacon lights with buzzer, multi-functional beacon lights				
LED unit type	Beacon			
Color	● Green	● Red	● Orange	● Blue
Voltage	12-24 VDC			
Reference	XVR3B03S	XVR3B04S	XVR3B05S	XVR3B06S
Voltage	100-230 VAC			
Reference	XVR3M03S	XVR3M04S	XVR3M05S	XVR3M06S

Beacon lights without buzzer

Color	● Green	● Red	● Orange	● Blue	
LED unit type	Beacon				
Voltage	12-24 VDC	XVR3B03	XVR3B04	XVR3B05	XVR3B06
	48 VDC	XVR3E03	XVR3E04	XVR3E05	XVR3E06
	100-230 VAC	XVR3M03	XVR3M04	XVR3M05	XVR3M06



Harmony XB4 metal pushbuttons



1 Pushbuttons with flush push, unmarked

Color	○ White	● Black	● Green	● Red	● Yellow	● Blue
Contact	NO		NC		NO	
Connection	Screw clamp terminals					
Complete product	XB4BA11	XB4BA21	XB4BA31	XB4BA42	XB4BA51	XB4BA61
Head	ZB4BA1	ZB4BA2	ZB4BA3	ZB4BA4	ZB4BA5	ZB4BA6
Complete flush mounting head in 30.5 mm diameter hole	XB4FA11	XB4FA21	XB4FA31	XB4FA42	XB4FA51	XB4FA61
Flush mounting head in 30.5 mm diameter hole	ZB4FA1	ZB4FA2	ZB4FA3	ZB4FA4	ZB4FA5	ZB4FA6
Body	ZB4BZ101		ZB4BZ102		ZB4BZ101	

2 Booted pushbuttons with flush push, unmarked

Complete product	–	XB4BP21	XB4BP31	XB4BP42	XB4BP51	XB4BP61
Head	ZB4BP1	ZB4BP2	ZB4BP3	ZB4BP4	ZB4BP5	ZB4BP6
Body	ZB4BZ101		ZB4BZ102		ZB4BZ101	

3 Pushbuttons with flush push, marked

Color	○ White	● Black	● Green	● Red	● Green	● Red
Marking	↑	↓	"I" (white)	"O" (white)	"START" (white)	"STOP" (white)
Contact	NO		NO + NC		NO	NO + NC
Connection	Screw clamp terminals					
Complete product	XB4BA3341	XB4BA3351	XB4BA3311	–	–	–
Head	ZB4BA334	ZB4BA335	ZB4BA331	ZB4BL432 (1)	ZB4BA333	ZB4BL434
Complete flush mounting head in 30.5 mm diameter hole	XB4FA3341	XB4FA3351	XB4FA3311	XB4FL4325 (1)	–	–
Flush mounting head in 30.5 mm diameter hole	ZB4FA334	ZB4FA335	ZB4FA331	ZB4FL432 (1)	ZB4FA333	ZB4FL434
Body	ZB4BZ101		ZB4BZ105		ZB4BZ101	ZB4BZ105



4 Ø 40 trigger action Emergency stop mushroom head pushbuttons

Color	● Red				
Contact	NO + NC Push-pull	1 NC monitoring Turn to release	2 NC Turn to release	NO + NC Turn to release	NO + NC Key release
Connection	Screw clamp terminals				
Complete product	XB4BT845	XB4BS8446	XB4BS8444	XB4BS8445	XB4BS9445
Head	ZB4BT84	ZB4BS844		ZB4BS944	
Body	ZB4BZ105	ZBE302 + ZB4BZ009	ZB4BZ104	ZB4BZ105	

5 Ø 40 mushroom head pushbutton, spring return

Color	● Black	● Green	● Blue	● Yellow
Contact	NO Push-pull			
Connection	Screw clamp terminals			
Complete product	XB4BC21	–	–	–
Head	ZB4BC2	ZB4BC3	ZB4BC6	ZB4BC5
Body	ZB4BZ101			

6 Illuminated ring for Emergency stop (2)

Color of the illuminated ring	○ White / ● Red		● Red		
Power supply	24 VAC/VDC			110... 120 VAC	230... 240 VAC
Complete product for standard mounting	Unmarked	ZBY9W3B140	ZBY9W2B140	ZBY9W2G140	ZBY9W2M140
	EMERGENCY STOP	ZBY9W3B330	ZBY9W2B330	ZBY9W2G330	ZBY9W2M330
	ARRET D'URGENCE	ZBY9W3B130	ZBY9W2B130	ZBY9W2G130	ZBY9W2M130
	PARADA DE EMERGENCIA	ZBY9W3B430	ZBY9W2B430	ZBY9W2G430	ZBY9W2M430
	NOT-HALT	ZBY9W3B230	ZBY9W2B230	ZBY9W2G230	ZBY9W2M230

(1) With projecting push

(2) For compliance with standard EN/ISO 13850, paragraph 4.4.6, the Emergency stop function logo  has been added.

Harmony XB4 metal pushbuttons



1 Pilot lights with integral LED

Color		○ White	● Green	● Red	● Orange	● Blue	● Yellow
Connection		Screw clamp terminals					
Complete product	24 VAC/VDC	XB4BVB1	XB4BVB3	XB4BVB4	XB4BVB5	XB4BVB6	ZBVB8 (1)
	110...120 VAC	XB4BVG1	XB4BVG3	XB4BVG4	XB4BVG5	XB4BVG6	ZBVG8 (1)
	230...240 VAC	XB4BVM1	XB4BVM3	XB4BVM4	XB4BVM5	XB4BVM6	ZBVM8 (1)
Complete flush mounting head in 30.5 mm diameter hole	24 VAC/VDC	XB4FVB1	XB4FVB3	XB4FVB4	XB4FVB5	XB4FVB6	ZBVB8 (2)
	110...120 VAC	XB4FVG1	XB4FVG3	XB4FVG4	XB4FVG5	XB4FVG6	ZBVG8 (2)
	230...240 VAC	XB4FVM1	XB4FVM3	XB4FVM4	XB4FVM5	XB4FVM6	ZBVM8 (2)

2 Illuminated pushbuttons with flush push and integral LED

Color		○ White	● Green	● Red	● Orange	● Blue	● Yellow
Contact		NO + NC					
Connection		Screw clamp terminals					
Complete product	24 VAC/VDC	XB4BW31B5	XB4BW33B5	XB4BW34B5	XB4BW35B5	XB4BW36B5	ZBVB8 (3)
	110...120 VAC	XB4BW31G5	XB4BW33G5	XB4BW34G5	XB4BW35G5	XB4BW36G5	ZBVG8 (3)
	230...240 VAC	XB4BW31M5	XB4BW33M5	XB4BW34M5	XB4BW35M5	XB4BW36M5	ZBVM8 (3)
Complete flush mounting head in 30.5 mm diameter hole	24 VAC/VDC	XB4FW31B5	XB4FW33B5	XB4FW34B5	XB4FW35B5	XB4FW36B5	ZBVB8 (4)
	110...120 VAC	XB4FW31G5	XB4FW33G5	XB4FW34G5	XB4FW35G5	XB4FW36G5	ZBVG8 (4)
	230...240 VAC	XB4FW31M5	XB4FW33M5	XB4FW34M5	XB4FW35M5	XB4FW36M5	ZBVM8 (4)



3 Selector switches and key switches

Positions (number and type)		2 ∨ Stay put	2 ∇ Spring return	2 ∨ Stay put	3 ∨ Stay put	3 ∇ Spring return
Contact		NO		NO + NC	2 NO	
Connection		Screw clamp terminals				
Complete product	Black handle	XB4BD21	XB4BD41	XB4BD25	XB4BD33	XB4BD53
	Long black handle	XB4BJ21	–	–	XB4BJ33	XB4BJ53
	Key switch (No. 455)	XB4BG21	XB4BG61	–	XB4BG33	–
Complete flush mounting head in 30.5 mm diameter hole	Black	XB4FD21	XB4FD41	XB4FD25	XB4FD33	XB4FD53
	Long black handle	XB4FJ21	–	–	XB4FJ33	XB4FJ53
	Key switch (No. 455)	XB4FG21	XB4FG61	–	XB4FG33	–

4 Illuminated selector switches with integral LED and colored handle

Stay put positions		2 ∨ Green	● Red	● Orange	3 ∨ Green	● Red	● Orange
Contact		NO + NC					
Connection		Screw clamp terminals					
Complete product	24 VAC/VDC	XB4BK123B5	XB4BK124B5	XB4BK125B5	XB4BK133B5	XB4BK134B5	XB4BK135B5
	110...120 VAC	XB4BK123G5	XB4BK124G5	XB4BK125G5	XB4BK133G5	–	–
	230...240 VAC	XB4BK123M5	XB4BK124M5	XB4BK125M5	XB4BK133M5	XB4BK134M5	XB4BK135M5
Complete flush mounting head in 30.5 mm diameter hole	24 VAC/VDC	XB4FK123B5	XB4FK124B5	XB4FK125B5	XB4FK133B5	XB4FK134B5	XB4FK135B5
	110...120 VAC	XB4FK123G5	XB4FK124G5	XB4FK125G5	XB4FK133G5	XB4FK134G5	XB4FK135G5
	230...240 VAC	XB4FK123M5	XB4FK124M5	XB4FK125M5	XB4FK133M5	XB4FK134M5	XB4FK135M5

5 Double- and triple-headed pushbuttons

Type	1 flush and 1 projecting	2 flush	1 flush and 1 projecting	2 flush	2 flush + 1 red central projecting
Contact	NO + NC		NO + NC with 24 V pilot light		2 NO + NC
Connection		Screw clamp terminals			
Complete product	XB4BL73415	–	XB4BW73731B5	–	XB4BA731327 –
Head	ZB4BL7341	ZB4BA7121	ZB4BW7L3741	ZB4BW7A1721	– ZB4BA71124
Body	ZB4BZ105		ZB4BZ105 + ZBVB1		ZB4BZ103 + ZBE102

(1) To get a complete pilot light, this body must be combined with a ZB4BZ009 socket and a ZB4BV083 head (to be ordered separately).

(2) To get a complete pilot light, this body must be combined with ZB4BZ009 socket and ZB4FV083 head (to be ordered separately).

(3) To get a complete illuminated pushbutton, this body must be combined with a ZB4BZ009 socket and a ZB4BW383 head (to be ordered separately).

(4) To get a complete pilot light, this body must be combined with ZB4BZ009 socket and ZB4FW383 head (to be ordered separately).

Harmony XB5 plastic pushbuttons



1 Pushbuttons with flush push, unmarked

Color	○ White	● Black	● Green	● Red	● Yellow	● Blue
Contact	NO		NC		NO	
Connection	Screw clamp terminals					
Complete product for standard mounting	XB5AA11	XB5AA21	XB5AA31	XB5AA42	XB5AA51	XB5AA61
Standard mounting head	ZB5AA1	ZB5AA2	ZB5AA3	ZB5AA4	ZB5AA5	ZB5AA6
Complete flush mounting head in 30.5 mm diameter hole	XB5FA11	XB5FA21	XB5FA31	XB5FA42	XB5FA51	XB5FA61
Flush mounting head in 30.5 mm diameter hole	ZB5FA1	ZB5FA2	ZB5FA3	ZB5FA4	ZB5FA5	ZB5FA6
Body	ZB5AZ101			ZB5AZ102	ZB5AZ101	

2 Booted pushbuttons with flush push, unmarked

Complete product for standard mounting	–	XB5AP21	XB5AP31	XB5AP42	XB5AP51	XB5AP61
Standard mounting head	–	ZB5AP2	ZB5AP3	ZB5AP4	ZB5AP5	ZB5AP6
Body	–	ZB5AZ101		ZB5AZ102	ZB5AZ101	

3 Pushbuttons with flush push, marked

Color	○ White	● Black	● Green	● Red	● Green	● Red
Marking	↑	↓	"I" (white)	"O" (white)	"START" (white)	"STOP" (white)
Contact	NO			NC	NO	NC
Connection	Screw clamp terminals					
Complete product for standard mounting	XB5AA3341	XB5AA3351	XB5AA3311	–	–	–
Standard mounting head	ZB5AA334	ZB5AA335	ZB5AA331	ZB5AL432 (1)	ZB5AA333	ZB5AL434
Complete flush mounting head in 30.5 mm diameter hole	XB5FA3341	XB5FA3351	XB5FA3311	XB5FL432 (1)	–	–
Flush mounting head in 30.5 mm diameter hole	ZB5FA334	ZB5FA335	ZB5FA331	ZB5FL432 (1)	ZB5FA333	ZB5FL434 (1)
Body	ZB5AZ101			ZB5AZ102	ZB5AZ101	ZB5AZ102



4 Ø 40 trigger action Emergency stop mushroom head pushbuttons

Color	● Red					
Contact	NO + NC Push-pull	1 NC monitoring Turn to release	2 NC Turn to release	NO + NC Turn to release	NO + NC Key release	
Connection	Screw clamp terminals					
Complete product for standard mounting	XB5AT845	XB5AS8446	XB5AS8444	XB5AS8445	XB5AS9445	
Standard mounting head	ZB5AT84	ZB5AS844			ZB5AS944	
Body	ZB5AZ105	ZBE302 + ZB5A2009	ZB5AZ104	ZB5AZ105		

5 Ø 40 mushroom head pushbuttons, spring return

Color	● Black	● Green	● Blue	● Yellow
Contact	NO Push-pull			
Connection	Screw clamp terminals			
Complete product for standard mounting	XB5AC21	–	–	–
Standard mounting head	ZB5AC2	ZB5AC3	ZB5AC6	ZB5AC5
Body	ZB5AZ101			

6 Illuminated Emergency stop head

Color of the illuminated ring	○ White / ● Red		● Red			
Power supply	24 VAC/VDC			110-120 VAC		230-240 VAC
Contact	NO + 2NC Turn to release	NO + NC Turn to release	NO + 2NC Turn to release	NO + NC Turn to release	NO + 2NC Turn to release	
Connection	Screw clamp terminals					
Complete product for standard mounting	XB5AS84W3B41	XB5AS84W3B5	–	–	–	–
Standard mounting head	ZB5AS84W3B		ZB5AS84W2B		ZB5AS84W2G	ZB5AS84W2M
Body	ZB5AZ141	ZB5AZ105	ZB5AZ141	ZB5AZ105	ZB5AZ141	

7 Illuminated ring for Emergency stop (2)

Color of the illuminated ring	○ White / ● Red		● Red			
Power supply	24 VAC/VDC			110-120 VAC		230-240 VAC
Complete product for standard mounting	Unmarked	ZBY9W3B140	ZBY9W2B140	ZBY9W2G140	ZBY9W2M140	
	EMERGENCY STOP	ZBY9W3B330	ZBY9W2B330	ZBY9W2G330	ZBY9W2M330	
	ARRET D'URGENCE	ZBY9W3B130	ZBY9W2B130	ZBY9W2G130	ZBY9W2M130	
	PARADA DE EMERGENCIA	ZBY9W3B430	ZBY9W2B430	ZBY9W2G430	ZBY9W2M430	
	NOT-HALT	ZBY9W3B230	ZBY9W2B230	ZBY9W2G230	ZBY9W2M230	

(1) With projecting push

(2) For compliance with standard EN/ISO 13850, paragraph 4.4.6, the Emergency stop function logo  has been added.

Harmony XB5 plastic pushbuttons



1 Pilot lights with integral LED

Color		○ White	● Green	● Red	● Orange	● Blue	● Yellow
Connection		Screw clamp terminals					
Complete product for standard mounting	24 VAC/VDC	XB5AVB1	XB5AVB3	XB5AVB4	XB5AVB5	XB5AVB6	ZBVB8 (1)
	110...120 VAC	XB5AVG1	XB5AVG3	XB5AVG4	XB5AVG5	XB5AVG6	ZBVG8 (1)
	230...240 VAC	XB5AVM1	XB5AVM3	XB5AVM4	XB5AVM5	XB5AVM6	ZBVM8 (1)
Monolithic product for standard mounting	24 VAC/VDC	XB5EVB1	XB5EVB3	XB5EVB4	XB5EVB5	XB5EVB6	XB5EVB8
	110...120 VAC	XB5EVG1	XB5EVG3	XB5EVG4	XB5EVG5	–	XB5EVG8
	230...240 VAC	XB5EVM1	XB5EVM3	XB5EVM4	XB5EVM5	XB5EVM6	XB5EVM8
Complete flush mounting head in 30.5 mm diameter hole	24 VAC/VDC	XB5FVB1	XB5FVB3	XB5FVB4	XB5FVB5	XB5FVB6	ZBVB8 (2)
	110...120 VAC	XB5FVG1	XB5FVG3	XB5FVG4	XB5FVG5	XB5FVG6	ZBVG8 (2)
	230...240 VAC	XB5FVM1	XB5FVM3	XB5FVM4	XB5FVM5	XB5FVM6	ZBVM8 (2)

2 Illuminated pushbuttons with flush push with integral LED

Color		○ White	● Green	● Red	● Orange	● Blue	● Yellow
Contact		NO + NC					
Connection		Screw clamp terminals					
Complete product for standard mounting	24 VAC/VDC	XB5AW31B5	XB5AW33B5	XB5AW34B5	XB5AW35B5	XB5AW36B5	ZBVB8 (3)
	110...120 VAC	XB5AW31G5	XB5AW33G5	XB5AW34G5	XB5AW35G5	XB5AW36G5	ZBVG8 (3)
	230...240 VAC	XB5AW31M5	XB5AW33M5	XB5AW34M5	XB5AW35M5	XB5AW36M5	ZBVM8 (3)
Complete flush mounting head in 30.5 mm diameter hole	24 VAC/VDC	XB5FW31B5	XB5FW33B5	XB5FW34B5	XB5FW35B5	XB5FW36B5	ZBVB8 (4)
	110...120 VAC	XB5FW31G5	XB5FW33G5	XB5FW34G5	XB5FW35G5	XB5FW36G5	ZBVG8 (4)
	230...240 VAC	XB5FW31M5	XB5FW33M5	XB5FW34M5	XB5FW35M5	XB5FW36M5	ZBVM8 (4)



3 Selector switches and key switches

Positions		2 ∨ Stay put	2 ∇ Spring return	2 ∨ Stay put	3 ∨ Stay put	3 ∇ Spring return	
Contact		NO		NO + NC	2 NO		
Connection		Screw clamp terminals					
Complete product for standard mounting	Black handle	XB5AD21	XB5AD41	XB5AD25	XB5AD33	XB5AD53	
	Long black handle	XB5AJ21	–	–	XB5AJ33	XB5AJ53	
	Key switch (No. 455)	XB5AG21	XB5AG61	–	XB5AG33	–	
Complete flush mounting head in 30.5 mm diameter hole	Black handle	XB5FD21	XB5FD41	XB5FD25	XB5FD33	XB5FD53	
	Long black handle	XB5FJ21	–	–	XB5FJ33	XB5FJ53	
	Key switch (No. 455)	XB5FG21	XB5FG61	–	XB5FG33	–	

4 Illuminated selector switches with integral LED and colored handle

Stay put positions		2 ∨	3 ∨				
Color		● Green	● Red	● Orange	● Green	● Red	● Orange
Contact		NO + NC					
Connection		Screw clamp terminals					
Complete product for standard mounting	24 VAC/VDC	XB5AK123B5	XB5AK124B5	XB5AK125B5	XB5AK133B5	XB5AK134B5	XB5AK135B5
	110...120 VAC	XB5AK123G5	–	XB5AK125G5	–	–	–
	230...240 VAC	XB5AK123M5	XB5AK124M5	XB5AK125M5	XB5AK133M5	XB5AK134M5	XB5AK135M5
Complete flush mounting head in 30.5 mm diameter hole	24 VAC/VDC	XB5FK123B5	XB5FK124B5	XB5FK125B5	XB5FK133B5	XB5FK134B5	XB5FK135B5
	110...120 VAC	XB5FK123G5	XB5FK124G5	XB5FK125G5	XB5FK133G5	XB5FK134G5	XB5FK135G5
	230...240 VAC	XB5FK123M5	XB5FK124M5	XB5FK125M5	XB5FK133M5	XB5FK134M5	XB5FK135M5

5 Double- and triple-headed pushbuttons

Type		1 flush 1 projecting	2 flush	1 flush 1 projecting	2 flush + 1 red central projecting	
Contact		NO + NC		NO + NC with 24V pilot light	2 NO + NC	
Connection		Screw clamp terminals				
Complete product		XB5AL73415	–	XB5AW73731B5	XB5AA731327	–
Head		ZB5AL7341	ZB5AA7121	ZB5AW7L3741	–	ZB5AA71124
Body		ZB5AZ105		ZB5AZ105 + ZBVB1	ZB5AZ103 + ZBE102	

(1) To get a complete pilot light, this body must be combined with a ZB5AZ009 socket and a ZB5AV083 head (to be ordered separately - see previous page).

(2) To get a complete pilot light, this body must be combined with ZB5AZ009 socket and ZB5FV083 head (to be ordered separately).

(3) To get a complete illuminated pushbutton, this body must be combined with a ZB5AZ009 socket and a ZB5AW383 head (to be ordered separately - see previous page).

(4) To get a complete illuminated pushbutton, this body must be combined with ZB5AZ009 socket and ZB5FW383 head (to be ordered separately).

Harmony XB4 and XB5 pushbuttons: other functions



1 Buzzer

Color		Black	Red illumination	Yellow illumination
Wiring connector		Screw clamp terminals		
Monolithic product	24 VAC/VDC	XB5KSB	XB5KS2B4	XB5KS2B8
	110...120 VAC/VDC	XB5KSG	XB5KS2G4	XB5KS2G8
	230...240 VAC	XB5KSM	XB5KS2M4	XB5KS2M8

2 USB and RJ45 ports

Description	Panel-mounted USB and RJ45 ports in 22.5 mm hole with notch		Protection covers		
Characteristics	USB interface, type A jack	Ethernet interface, RJ45 jack	Black	Rigid, transparent	Metal
Connection type	USB port 3.0 A-A	RJ45 port Cat. 6	–	–	–
Degree of protection	IP20	IP20	IP65/IP67	IP65/IP67	IP65/IP67/IP69K
Reference	XB5PUSB3	XB5PRJ45	ZBSP1	ZBSP2	ZBSP3



3 Timers

Description	Panel-mounted timer function with LED status and 1 static output in 22.5 mm hole				
Output type	1 static output				
Time delay type	Type A (delay on energization)				
Time delay range	0.5...10 s	3...60 s	0.5...10 min	3...60 min	
Reference	24 VDC	XB5DTB22	XB5DTB23	XB5DTB24	XB5DTB25
	100...240 VAC 50/60 Hz	XB5DTGM2	XB5DTGM3	XB5DTGM4	XB5DTGM5



4 3-phase pilot lights with integral LED

Description	Panel-mounted 3-phase voltage indicator pilot lights with 3 LEDs in 30 mm hole		
Connection	Faston connector, 6.3 mm		
Colors	● ● ● Red, green, yellow	○ ○ ○ 3 white LEDs	
Complete product	400 VAC	XB5EV57K4	XB5EV57L4

5 XB4 complete potentiometers

Description	Panel-mounted complete potentiometers in 22.5 mm hole		
Connection	Screw terminals		
Resistance (in kΩ)	1	4.7	10
Reference	XB4BD912R1K	XB4BD912R4K7	XB4BD912R10K
Resistance (in kΩ)	47	100	470
Reference	XB4BD912R47K	XB4BD912R100K	XB4BD912R470K

6 XB5 complete potentiometers

Description	Panel-mounted complete potentiometers in 22.5 mm hole		
Connection	Screw terminals		
Resistance (in kΩ)	1	4.7	10
Reference	XB5AD912R1K	XB5AD912R4K7	XB5AD912R10K
Resistance (in kΩ)	47	100	470
Reference	XB5AD912R47K	XB5AD912R100K	XB5AD912R470K

Harmony: other functions



1 Harmony XB5S biometric switches standalone

Receiver	Monostable	Bistable
Power supply	24 VDC/PNP output	
Cable 2 m	XB5S2B2L2	XB5S1B2L2
M12 connector	XB5S2B2M12	XB5S1B2M12

2 Harmony XB5S biometric switches RGPD/USB

Receiver	Monostable	Bistable		
Power supply	24 VDC/PNP output			
Features	Standalone RGPD	USB RGPD	Standalone RGPD	USB RGPD
Cable 2 m	XB5S6B2L2	XB5S9B2L2	XB5S7B2L2	XB5S8B2L2
M12 connector	XB5S6B2M12	XB5S9B2M12	XB5S7B2M12	XB5S8B2M12



3 Harmony XB5 digital panel meter

Product type	Display module	
LED color	Green	Red
Input range	4...20 mA DC	
Reference	XBH1AA0R4	XBH1AA0G4

4 RFID operator interface

Description	RFID Reader with key holder	User tag with 2 master key and 2 reset key
Supply Voltage	24 VDC	
Set of	1	10
Reference	ZB5SKR01	ZB5SKT01

5 Harmony Pocket Remote

Receiver	Connection	Pre-wired 1.5 m				
	Power supply	12-24 VDC				
	Standard output	5	11			
	Reference	ZARB05WSP	ZARB11WSP			
Transmitter	No. of pushbuttons	3	4	6	8	10
	Reference	ZART03	ZART04	ZART06	ZART08	ZART10



6 Harmony XB4R/XB5R wireless and batteryless pushbuttons

Receiver	Non-programmable + 1 black cap		
Power supply	24 VDC		
Pushbutton	1 plastic	1 metal	1 plastic in handy box
Reference	XB5RFB01	XB4RFA02	XB5RMB03



7 Harmony Hub wireless gateway

Receiver	Modbus/TCP Ethernet	Modbus serial line		
Power supply	24 VDC			
Reference	ZBRN1	ZBRN2		
Accessories	ZBRCETH	–		
Relay antenna	ZBRA1	ZBRA1		
Passive antenna	ZBRA2	ZBRA3	ZBRA2	ZBRA3

Accessories for Harmony pushbuttons



Harmony Hub Ecosystem

Type	Temperature & Humidity Sensor	Self-powered current monitoring wireless clamp	Self-powered current monitoring wireless clamp	Self-powered current monitoring wireless clamp
Measurement Range	-25...90 °C at 35 °C 10%...98%	0.5 A to 35 A	2.5 A to 180 A	7 A to 500 A
Reference	ZBRTT1	ZBRTC1	ZBRTC2	ZBRTC3

1

1 Contact blocks (for XB4 and XB5 pushbuttons)

Type	Electrical blocks				Body fixing collars for XB4 or XB5	
Contact	NO	NC	NO	NC	–	–
Connection	Screw clamp terminals		Spring clamp terminals		–	–
Sold in lots of	5	5	4	4	10	
Reference	Contact block	ZBE101	ZBE102	ZBE1015	ZBE1025	ZB4BZ009 ZB5AZ009

2 Light blocks with integral LED (for XB4 and XB5 pushbuttons)

Color	<input type="radio"/> White	<input type="radio"/> Green	<input type="radio"/> Red	<input type="radio"/> Orange	<input type="radio"/> Blue	<input type="radio"/> Yellow		
Connection	Screw clamp terminals							
Reference	Contact block	24 VAC/VDC 110...120 VAC 230...240 VAC	ZBVB1 ZBVG1 ZBVM1	ZBVB3 ZBVG3 ZBVM3	ZBVB4 ZBVG4 ZBVM4	ZBVB5 ZBVG5 ZBVM5	ZBVB6 ZBVG6 ZBVM6	ZBVB8 ZBVG8 ZBVM8

3 Wireless and battery-less interface to be used with ZBRR and ZBRN (for XB4 and XB5 pushbuttons)

Function	Push only (1 state)	Push and release (2 states)
Reference	ZBRT1	ZBRT2

4 Legend holders 30 x 40 mm for 8 X 27 mm legends Ø 60 legends for Emergency stop

White marking/Red or black background				Black marking/Yellow background			
O	–	I	ZBY2147	AUTO	–	ARRET D'URGENCE	ZBY9120 ZBY9130T (1)
OFF	ZBY2312	ON	ZBY2311	START	ZBY2303	EMERGENCY STOP	ZBY9320 ZBY9330T (1)
Without marking/Red or black background				Without marking/Yellow background			
Red	ZBY2101	Black	ZBY2101			ZBY9121	



5 Illuminated ring without legend for customization(Use with ZBY9W101)

Description	Ø60 mm, can be used with all Ø22 mm heads	Ø60 mm, can be used with all Ø22 mm heads
Marking	No Marking	No Marking
Signaling	Fixed, Red	Fixed, Red + white
Supply Voltage	24 V	24 V
Reference	ZBY9W2B501	ZBY9W3B501

6 Customizable Circular legend for illuminated ring without legend (1)

Description	Ø60 mm
Reference	ZBY9W101

7 Legend holders for flush mounting head

Without legend				With blank legend without marking, black or red background			
8 x 27 mm legend for XB4F & XB5F	ZBZF32	18 x 27 mm legend	ZBZF33	8 x 27 mm legend	ZBYF2101	18 x 27 mm legend	ZBYF6101

8 Transparent boots for pushbuttons (sold in lots of 10)

For pushbuttons	Circular projecting	Circular flush	Circular flush or projecting	Flush, double headed	Triple headed	Flush/projecting double headed
Reference	ZBP0	ZBPA	ZBP0A	ZBA708	ZBA709	ZBA710

9 Flush mounting kits

For use with	Pushbuttons and pilot lights				Selector switches and illuminated pushbuttons		
Range and appearance	XB4 chromium plated, depth 9.8 mm	XB5 plastic, black depth 9.8 mm	XB5 plastic, black, depth 12.3 mm with 1- or 2-line legend	XB5 plastic, black, depth 12.3 mm	XB5 plastic, black, depth 12.3 mm with 1- or 2-line legend	1-line legend	2-line legend
Reference	ZB4BZ021	ZB5AZ021	ZB5AZ023 ZB5AZ025	ZB5AZ022	ZB5AZ024	ZB5AZ026	

(1) Create customized marking on this reference using the web customization tool.

Harmony XAP die-cast metal enclosures



1 Harmony XAPK (yellow RAL 1004) (1)									
Usable depth	49 mm			74.5 mm					
Number of cut-outs (22 mm)	0	1	0	1					
Dimension (W x H)/ Cable gland hole	80 x 80 / M20	XAPK11	XAPK1201	XAPK14	XAPK1501				
2 Harmony XAPD with 49 mm usable depth (gray RAL 7035) (1)									
Number of cut-outs (22 mm)	0	1	2	3	4	6			
Dimension (W x H)/ Cable gland hole	80 x 80 / M20	XAPD11	XAPD1201	XAPD1202	–	–	–		
	80 x 130 / M20	XAPD21	–	XAPD2202	XAPD2203	XAPD2204	–		
	80 x 175 / M25	XAPD31	–	–	XAPD3203	XAPD3204	XAPD3206		
3 Harmony XAPD with 74.5 mm usable depth (gray RAL 7035) (1)									
Number of cut-outs (22 mm)	0	1	2	3	4	5	6	8	10
Dimension (W x H)/ Cable gland hole	80 x 80 / M20	XAPD14	XAPD1501	XAPD1502	–	–	–	–	–
	80 x 130 / M20	XAPD24	–	XAPD2502	XAPD2503	XAPD2504	–	–	–
	80 x 175 / M25	XAPD34	–	–	XAPD3503	XAPD3504	–	XAPD3506	–
	80 x 220 / M25	XAPD44	–	–	–	XAPD4504	XAPD4505	XAPD4506	XAPD4508
	80 x 310 / M32	XAPD54	–	–	–	–	XAPD5505	–	XAPD5508
Number of cut-outs (30 mm)	0	1	2	3	4	5	6	8	10
Dimension (W x H)/ Cable gland hole	80 x 80 / M20	–	XAPD1601 (2)	–	–	–	–	–	–
	80 x 130 / M20	–	–	XAPD2602 (2)	–	–	–	–	–
	80 x 175 / M25	–	–	–	XAPD3603 (2)	–	–	–	–
	80 x 220 / M25	–	–	–	–	XAPD4604 (2)	–	–	–
	80 x 310 / M32	–	–	–	–	–	XAPD5606 (2)	–	–
4 Harmony XAPO with 74.5 mm usable depth (orange RAL 2008)									
Cut-outs diameter	22 mm					30 mm with notch			
Number of cut-outs	1	2	3	4	6	1	2	3	4
Dimension (W x H)/ Cable gland hole	80 x 80 / M20	XAPO1501	–	–	–	–	XAPO1601	–	–
	80 x 130 / M20	–	XAPO2502	–	–	–	–	XAPO2602	–
	80 x 175 / M25	–	–	XAPO3503	XAPO3504	–	–	–	XAPO3603
	80 x 220 / M25	–	–	–	–	XAPO4506	–	–	XAPO4604
5 Harmony XAPG with 49 mm usable depth (gray RAL 7032)									
Number of cut-outs (22 mm)	0	1	2	3	4				
Dimension (W x H)/ Cable gland hole	80 x 80 / 3/4 NPT	XAPG19100	XAPG19201	XAPG19702	–	–			
	80 x 130 / 3/4 NPT	XAPG29100	–	XAPG29202	XAPG29703				
	80 x 175 / 3/4 NPT	XAPG39100	–	–	XAPG39203	XAPG39704			
6 Harmony XAPG with 74.5 mm usable depth (gray RAL 7032)									
Number of cut-outs (22 mm)	0	1	2	3	4	5			
Dimension (W x H)/ Cable gland hole	80 x 80 / 3/4 NPT	XAPG19400	XAPG19501	XAPG19802	–	–	–		
	80 x 130 / 3/4 NPT	XAPG29400	–	XAPG29502	XAPG29803	–	–		
	80 x 175 / 3/4 NPT	XAPG39400	–	–	XAPG39503	XAPG39804	–		
	80 x 220 / 3/4 NPT	XAPG49400	–	–	–	XAPG49504	–		
	80 x 310 / 3/4 NPT	XAPG59400	–	–	–	–	XAPG59505		
Number of cut-outs (30 mm)	0	1	2	3	4	5			
Dimension (W x H)/ Cable gland hole	80 x 80 / 3/4 NPT	–	XAPG19601	–	–	–			
	80 x 130 / 3/4 NPT	–	–	XAPG29602	–	–			

(1) Full customization of front cover with legend panel is possible through online product configurator.
 (2) Flush mounting head can be mounted with ZB4FBZ014 accessory.

Harmony XAL plastic control stations



1 Control stations with 1 pushbutton, type XALD						
Number and type of pushbuttons		1 start or stop			1 start and stop	
Color or type		● Green	● Green	● Red	● Handle	● Key
Marking		"I" (white)	"START" (white)	"O" (white)	"O-I" (white)	"O-I" (white)
Contact		NO		NC	NO	
Connection		Screw clamp terminals				
Complete product	Flush pushbutton	XALD102 (2)	XALD103 (2)	XALD112	–	–
	Selector switch	–	–	–	XALD134 (2)	XALD144 (2)
2 Control stations with 1 Emergency stop pushbutton, type XALK						
Number and type of pushbuttons		1 x Ø 40 trigger action Emergency stop mushroom head pushbutton				
Color		● Red				
Type		Turn to release			Key release	
Contact		1 NC monitoring	NC	2 NC	2 NC + NO	NC
Connection		Screw clamp terminals				
Complete product		XALK1786	XALK178 (2)	XALK178F (2)	XALK178G (2)	XALK188 (2)
					XALK188F	XALK188G (2)
3 Control stations with pushbuttons, type XALD						
Number and type of pushbuttons		2 start and stop flush mounting			2 up/down flush mounting	
Color/Marking		1 "I" green	1 "Start" green	1 pilot light 24 VDC	1 "Up" white	
		1 "O" red	1 "Stop" red	1 "I" green	1 "Down" black	1 "O" red
		–	–	1 "O" red	–	1 "Down" black
Contact		NO + NC			2 NO	NO + NC + NO
Connection		Screw clamp terminals				
Complete product		XALD213 (2)	XALD215 (2)	XALD363B (2)	XALD222 (2)	XALD324 (2)
					XALD328 (2)	

(1) For padlocking device ZBZ3606

(2) Add H7 for UL/CSA conforming version, e.g. XALD102H7.

Harmony XAC pendant control stations



Harmony XACA pendant control stations for Ø 22 plastic signaling units					
Number of pushbuttons	2	3	4	6	8
Type	Pistol grip			Standard	
Color	Yellow			Yellow	
Pushbutton 1: Raise (1)	Yes	Yes	Yes	Yes	Yes
Pushbutton 2: Lower (1)	Yes	Yes	Yes	Yes	Yes
Emergency stop (2)	–	Yes	–	–	–
Pushbutton 3: Left (1)	–	–	Yes	Yes	Yes
Pushbutton 4: Right (1)	–	–	Yes	Yes	Yes
Pushbutton 5: Forward (1)	–	–	–	Yes	Yes
Pushbutton 6: Reverse (1)	–	–	–	Yes	Yes
Pushbutton 7: O (1)	–	–	–	–	Yes
Pushbutton 8: I (1)	–	–	–	–	Yes
Reference	XACA201	XACA2014	XACA471	XACA671	XACA871

(1) With NO contact

(2) With NC contact

Choose your style with Harmony customization tool

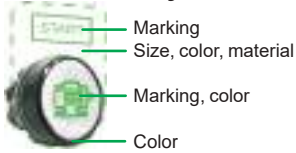

1

Pushbutton Ø 22 mm: base product customizable (1)

Type	Harmony XB4B, metal	Harmony XB5A, plastic
Pushbutton, black, 1 NO contact block	XB4BA21	XB5AA21
Selector switch, 2 positions, 1 NO contact block	–	XB5AD21
Pilot light, red, 24 VAC/VDC	XB4BVB4	XB5AVB4
Legend plate, 30 x 50 mm, dark gray color	ZBYM6101	ZBYP6101
Legend holder, 30 x 50 mm	–	ZBY6101



Flush mounted pushbutton: base product customizable (1)

Type	Harmony XB4F, metal	Harmony XB5F, plastic
Pushbutton, black, 1 NO contact block	XB4FA21	XB5FA21
Selector switch, 2 positions, 1 NO contact block	XB4FD21	XB5FD21
Pilot light, red, 24 VAC/VDC	XB4FVB4	XB5FVB4
Legend plate, 30 x 50 mm, dark gray color	–	ZBYFP6101
Legend holder, 40 x 50mm	–	ZBYF2101



Plastic control station: base product customizable (1)

Type	Gray color	Yellow color
1 hole	XALD01	XALK01
2 holes	XALD02	–
5 holes	XALD05	–



Legend panel: base product customizable (1)

Template size (mm/in.)	Reference
100 x 100/3.93 x 3.93	ZBYLEG101000
300 x 400/11.81 x 15.74	ZBYLEG304000
500 x 400/19.68 x 15.74	ZBYLEG504000

(1) Fast, easy, and intuitive: for other color or type

- 1 Go to product selector
- 2 Select your device
- 3 Define your customization



Harmony XB7 Ø 22 monolithic pushbuttons



Pushbutton with flush push, unmarked

Color	○ White	● Black	● Green	● Red	● Yellow	● Blue
Contact	NO			NO + NC		
Connection	Screw clamp terminals					
Complete product	XB7NA11	XB7NA21	XB7NA31	XB7NA45	XB7NA85	XB7NA65



Pushbutton with flush push, marked

Color	○ White	● Black	● Green	● Green	● Red
Marking	↑	↓	"I" (white)	"START" (white)	"STOP" (white)
Contact	NO			NO	NC
Connection	Screw clamp terminals				
Complete product	XB7NA11341	XB7NA21343	XB7NA3131	XB7NA3133	XB7NA4234



Ø 40 trigger action Emergency stop mushroom head pushbuttons

Color	● Red		
Contact	NO + NC Push-pull	NO + NC Turn to release	2 NC Key release
Connection	Screw clamp terminals		
Complete product	XB7NT845	XB7NS8445	XB7NS9444



Pilot lights with integral LED

Color	● Green	● Red	● Yellow	● Blue	○ Clear	● Orange	
Connection	Screw clamp terminals						
Complete product	24 VAC/VDC	XB7EV03BP	XB7EV04BP	XB7EV05BP	XB7EV06BP	XB7EV07BP	XB7EV08BP
	120 VAC	XB7EV03GP	XB7EV04GP	XB7EV05GP	XB7EV06GP	XB7EV07GP	XB7EV08GP
	230 VAC	XB7EV03MP	XB7EV04MP	XB7EV05MP	XB7EV06MP	XB7EV07MP	XB7EV08MP



Illuminated pushbutton with flush push with integral LED

Color	● Green	● Red	● Orange	● Blue	○ Clear	● Yellow	
Contact	NO + NC						
Connection	Screw clamp terminals						
Complete product	24 VAC/VDC	XB7NW33B1	XB7NW34B1	XB7NW35B1	XB7NW36B1	XB7NW37B1	XB7NW38B1
	120 VAC	XB7NW33G1	XB7NW34G1	–	XB7NW36G1	XB7NW37G1	XB7NW38G1
	230 VAC	XB7NW33M1	XB7NW34M1	XB7NW35M1	–	XB7NW37M1	XB7NW38M1



Selector switches with black handle

Positions	2 ∨	2 ∨	3 ∨	2 ∨	3 ∨	
Type	Stay put			Key withdrawal in LH position	Key withdrawal in center position	
Contact	NO	NO + NC	2 NO	NO	2 NO	
Connection	Screw clamp terminals					
Complete product	24 VAC/VDC	XB7ND21	XB7ND25	XB7ND33	XB7NG21	XB7NG33

Other control components



Harmony XD4 joystick controllers

Number of directions	2	4	2	4
Contact	1 NO per direction			
Position	Stay put		Spring return	
Reference	XD4PA12	XD4PA14	XD4PA22	XD4PA24

Harmony cam switches

Function	Ammeter	Voltmeter	Changeover	ON-OFF switches	Stepping	
Thermal current	12 Amps					
Number of poles	6	6	4	1	3	3
Multi-screw fixing	K1F003MLH	K1F027MLH	K1D002ULH	K1A001ALH	K1C003ALH	K1C003QLH
Ø 22 fixing	K1F003MCH	K1F027MCH	K1D002UCH	K1A001ACH	–	K1C003QCH

Harmony XPE foot switches

Material/Color	Plastic black	Plastic yellow	Metal blue	Metal blue	Metal blue	Metal orange
Cover	No	Yes	No	No	Yes	Yes
Contact	1 NC + 1 NO		2 NC + 2 NO		1 NC + 1 NO	
Without trigger mechanism	XPEA110	XPEY310	XPEM110	XPEM111	XPEM310	XPER310
Trigger mechanism	–	XPEY510	XPEM810	–	XPEM510	XPER510

Harmony remote control system and pendant control stations for hoisting



Harmony wireless remote control system (basic)

Motion pushbutton	6		
Auxiliary pushbuttons	1		
LED or display	LED		
Emergency stop mushroom head	1 Emergency stop mushroom head SIL 2 cat 3 PLd		
Base	Standard output	10	
	Safety output	2	
Handheld	Reference	ZART8LS	
Base	Power supply	48...240 VAC	24 VDC
	Connection	Cable gland	Pre-wired 1.5 m
	Reference	ZARB10WS	ZARB10WSP

Harmony wireless remote control system (standard)

Motion pushbutton	6			
Auxiliary pushbuttons	2	2	6	
LED or display	LED	Display	Display	
Emergency stop mushroom head	1 Emergency stop mushroom head SIL 3 cat 4 PLd			
Base	Standard output	12	18	
	Safety output	2	2	
Inputs	–	–	18	
Handheld	Reference	ZART8L	ZART8D	ZART12D
Base	Reference	ZARB12W	ZARB18W	ZARB18W
	Connection	Cable gland		





02. Harmony Human Machine Interfaces (HMI) – Basic panels

Harmony ST6, STW6, and STM6 basic panels



Harmony ST6 - New level of aesthetics with visually powerful EcoStruxure Operator Terminal Expert software					
Screen size	4.3"	7"	10.1"	12.1"	15.6"
Screen resolution (pixels)	480 x 272	800 x 480	1,024 x 600	1,280 x 800	1,366 x 768
Touch screen or keypad	Touch screen				
Software	EcoStruxure Operator Terminal Expert				
Memory capacity	Application memory	128 MB			
	Backup memory	NVRAM 512 KB			
	Expansion memory	No			
Communication	Ethernet port	IEEE802.3i/IEEE802.3u, 10BASE-T/ 100BASE-TX x1	IEEE802.3i/IEEE802.3u, 10BASE-T/100BASE-TX x2		
	Serial line	RS-232C/485 (COM1)	RS-232C (COM1) and RS-485 (COM2)		
	USB connection	USB 2.0 (Type A) + USB 2.0 (micro-B)			
Operating temperature	0...50 °C				
Industrial certifications	CE, UL, cUL, RMC, KC, EAC, RoHS, and WEEE				
Cut-out (mm)	118.5 x 92.5	190 x 135	255 x 185	295 x 217	394 x 250
Dimensions (mm)	134.5 x 108.5 x 43	208 x 153 x 45	273 x 203 x 47	313 x 235 x 50	412 x 268 x 50
Reference	HMIST6200	HMIST6400	HMIST6500	HMIST6600	HMIST6700

2



Harmony STW6 - New level of aesthetics and ready-to-use with a pre-installed browser					
Screen size	4.3"	7"	10.1"	12.1"	15.6"
Screen resolution (pixels)	480 x 272	800 x 480	1,024 x 600	1,280 x 800	1,366 x 768
Touch screen or keypad	Touch screen				
Software	Linux Browser HTML5				
Memory capacity	System memory	512 MB			
	Backup memory	NVRAM 128 KB			
	Expansion memory	No			
Communication	Ethernet port	IEEE802.3i/IEEE802.3u, 10BASE-T/ 100BASE-TX x1	IEEE802.3i/IEEE802.3u, 10BASE-T/100BASE-TX x2		
	Serial line	No			
	USB connection	USB 2.0 (Type A) + USB 2.0 (micro-B)			
Operating temperature	0...50 °C				
Industrial certifications	CE, UL, cUL, RMC, KC, EAC, RoHS, and WEEE				
Cut-out (mm)	118.5 x 92.5	190 x 135	255 x 185	295 x 217	394 x 250
Dimensions (mm)	134.5 x 108.5 x 43	208 x 153 x 45	273 x 203 x 47	313 x 235 x 50	412 x 268 x 50
Reference	HMISTW6200	HMISTW6400	HMISTW6500	HMISTW6600	HMISTW6700



Harmony STM6 - New level of aesthetics with unique pushbutton 22 mm mounting system					
Screen size	4.3"	7"	-		
Screen resolution (pixels)	480 x 272	800 x 480	-		
Touch screen or keypad	Touch screen				
Software	EcoStruxure Operator Terminal Expert				
Memory capacity	Application memory	128 MB			
	Backup memory	NVRAM 512 KB			
	Expansion memory	No			
Communication	Ethernet port	IEEE802.3i/IEEE802.3u, 10BASE-T/100BASE-TX			
	Serial line	RS-232C/485 (COM1)x2			
	USB connection	USB 2.0 (Type A) + USB 2.0 (micro-B)			
Operating temperature	0...50 °C				
Industrial certifications	CE, UL, cUL, RMC, KC, EAC, UL Class1 Div2, ATEX Zone 2/22, Marine, RoHS, and WEEE				
Cut-out (mm)	hole 22.5	hole 22.5	DIN Rail mounting		
Dimensions (mm)	145.6 x 108.2 x 53.9	201.2 x 137.2 x 57.7	150.49 x 109.97 x 63.3		
Reference	HMISTM6200	HMISTM6400	HMISTM6BOX		

Harmony STO basic panels

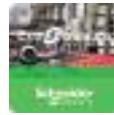

Harmony STO7 touch panels - most compact panels

Screen size		4.3"		
Screen resolution (pixels)		480 x 272		
Touch screen or keypad		Touch screen		
Software		EcoStruxure Operator Terminal Expert		
Memory capacity	Application memory	26 MB		
	Backup memory	128 KB		
	Expansion memory	No		
Communication	Ethernet port	No		1 LAN port
	Serial line	RS-232C (9-way terminal block)	RS-232C/RS-485 (RJ45 8-way)	No
	USB connection	1 type A host connector + 1 mini-B connector		
Operating temperature		0...50 °C		
Industrial certifications		CE, RCM, EAC, KC, CUL, UL, ATEX Zone 2/22		
Cut-out (mm) (1)		112.5 x 77.5		
Dimensions (mm)		124.9 x 90.4 x 38.8		
Reference		HMISTO705	HMISTO715	HMISTO735

(1) An accessory adapter is available to fit in monochrome STO cut-out.

2

Programming software and USB accessories



EcoStruxure Operator Terminal Expert, programming software for Harmony ST6, ST07, and STM6 basic panels

Compatibility	All Harmony ST6 and STO7 basic panels			
Type of EcoStruxure Operator Terminal Expert license	Professional License (1)	Professional License (1) (3)	Basic Edition License (2)	Basic Edition License (2) (3)
Number of stations	1			
License format	Printed	Digital	Printed	Digital
License duration	Unlimited			
Reference	HMIPELCZLSPMZZ	HMIPELCZSPAZZ	HMIELCZLSPMZZ	HMIELCZLSPAZZ



2

USB accessories for basic panels

USB accessories	Monolithic USB tower lights		Illuminated USB switch	USB keyboard
Degree of protection	IP54		IP65	
Description	<ul style="list-style-type: none"> - 3 multi-color LEDs - clear lens - 2-tone buzzer (up to 85 dB at 1 m) - pre-assembled USB cable for easy connection - USB cable clamp to help ensure firm connection 		5 customizable soft/static function keys with multi-color LED backlight or alarm acknowledgment	USB keyboard with 12 keys with integrated LEDs that can be used as user customizable function keys or alpha-numeric input keys
Type of mounting	Base for direct mounting	100 mm aluminum support tube mounted on a plate	–	–
Compatibility	(4)			
Reference	XVGU3SWV	XVGU3SHAV	HMIZRA1	HMIZKB1

(1) Supports Web Server API in ST6/STO7 and OPC UA in ST6.

(2) Does not support Web Server API or OPC UA.

(3) Please check the availability of the digital format with your local Schneider Electric contact.



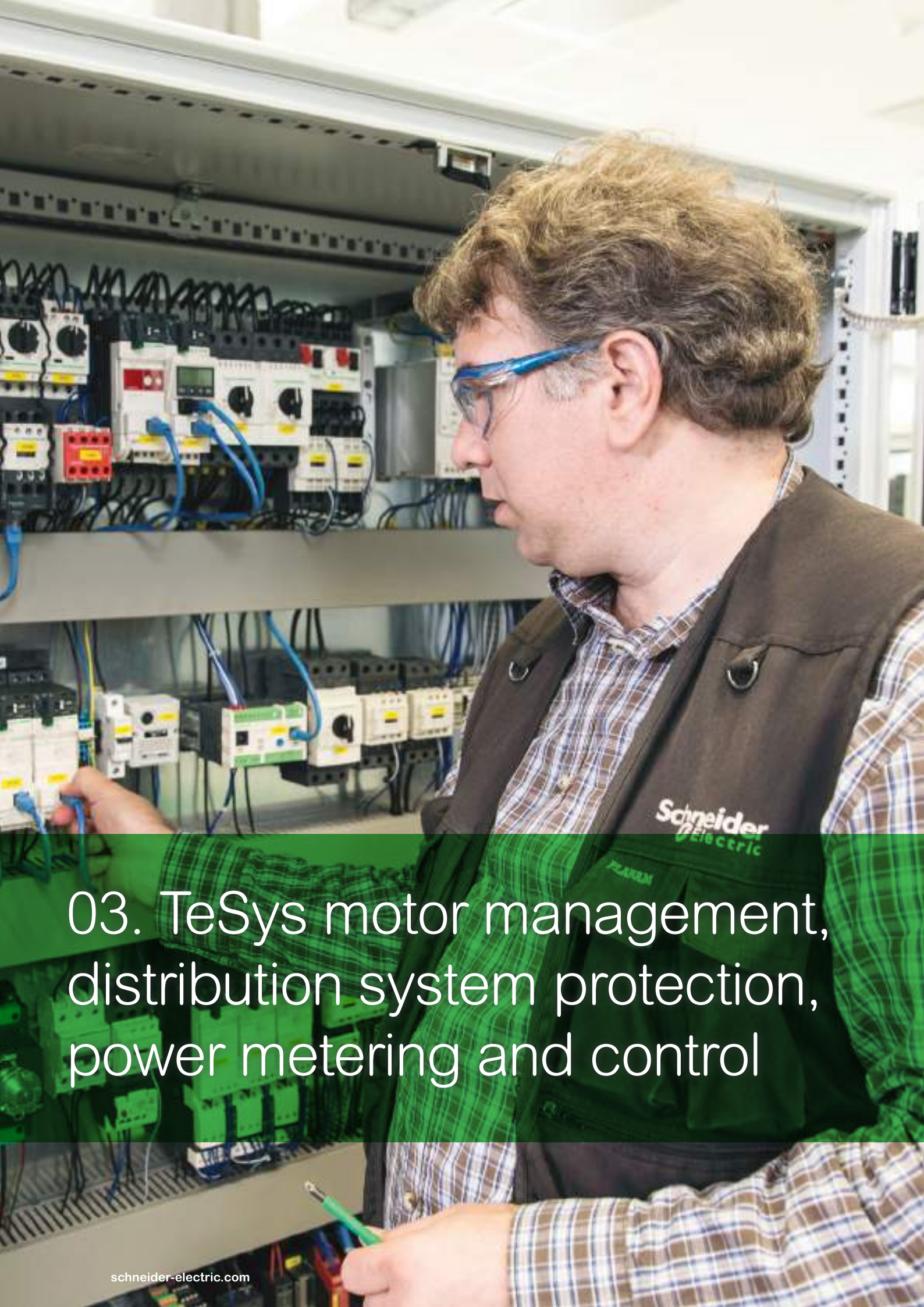

(4) Please check the availability of software with your local Schneider Electric contact.



03. TeSys motor management, distribution system protection, power metering and control

TeSys Universal

Build your motor starter!

	Contactor	Thermal-magnetic circuit breaker	Magnetic circuit breaker	Switch-disconnector fuse	Thermal overload relay	Ultra compact motor starter
Range name	TeSys K, TeSys Deca & Giga	TeSys GV,ME/P	TeSys GV.L	TeSys GS	TeSys K, TeSys Deca & Giga	TeSys H
Product reference prefix	LC	GV	GV.L	GS	LR	LZ
Motor starter structure - 4 functions to be covered:						
 Disconnection and breaking	<input type="checkbox"/>	<input checked="" type="checkbox"/>	<input checked="" type="checkbox"/>	<input checked="" type="checkbox"/>	<input type="checkbox"/>	<input type="checkbox"/>
 Short-circuit protection	<input type="checkbox"/>	<input checked="" type="checkbox"/>	<input checked="" type="checkbox"/>	<input checked="" type="checkbox"/>	<input type="checkbox"/>	<input type="checkbox"/>
 Overload protection	<input type="checkbox"/>	<input checked="" type="checkbox"/>	<input type="checkbox"/>	<input type="checkbox"/>	<input checked="" type="checkbox"/>	<input checked="" type="checkbox"/>
 Control	<input checked="" type="checkbox"/>	<input type="checkbox"/>	<input type="checkbox"/>	<input type="checkbox"/>	<input type="checkbox"/>	<input checked="" type="checkbox"/>

Voltage coil code

	■ ■	■ ■	■ ■
	AC	DC	DC < 2.4 V
24 V	B7	BD	BL
48 V	E7	ED	EL
110 V	F7	FD	
220 V	M7		
230 V	P7		







Motor power AC3 380/400 V	0.37...0.55 kW	0.75 kW	1.1...1.5 kW	2.2 kW	3 kW	4 kW	5.5 kW
TeSys K mini contactor (1)							
le max. AC3 (Ue ≤ 440 V)	6 A	6 A	6 A	6 A	9 A	9 A	12 A
le AC1 (T < 60°C)	20 A	20 A	20 A	20 A	20 A	20 A	20 A
Contactors with NO auxiliary contact (2)	LC1K0610 ■■	LC1K0610 ■■	LC1K0610 ■■	LC1K0610 ■■	LC1K0910 ■■	LC1K0910 ■■	LC1K1210 ■■
Contactors with NC auxiliary contact (2)	LC1K0601 ■■	LC1K0601 ■■	LC1K0601 ■■	LC1K0601 ■■	LC1K0901 ■■	LC1K0901 ■■	LC1K1201 ■■
Breaking capacity Icu/400 V	100 KA	100 KA	100 KA	100 KA	100 KA	100 KA	100 KA
Thermal-magnetic circuit breaker	GV2P06	GV2P07	GV2P08	GV2P10	GV2P14	GV2P14	GV2P16
Rotary handle							
Breaking capacity Icu/400 V	100 KA	100 KA	100 KA	100 KA	100 KA	100 KA	15 KA
Thermal-magnetic circuit breaker	GV2ME06	GV2ME07	GV2ME08	GV2ME10	GV2ME14	GV2ME14	GV2ME16
Pushbutton control							
Breaking capacity Icu/400 V	100 KA	100 KA	100 KA	100 KA	100 KA	100 KA	15 KA
Magnetic circuit breaker	GV2LE06	GV2LE07	GV2LE08	GV2LE10	GV2LE14	GV2LE14	GV2LE16
Tumbler control							
Breaking capacity Icu/400 V	100 KA	100 KA	100 KA	100 KA	100 KA	100 KA	100 KA
Magnetic circuit breaker	GV2L06	GV2L07	GV2L08	GV2L10	GV2L14	GV2L14	GV2L16
Rotary handle							
Switch-disconnector fuse	GS1DD	GS1DD	GS1DD	GS1DD	GS1DD	GS1DD	GS1DD
Fuse type	10 x 38	10 x 38	10 x 38	10 x 38	10 x 38	10 x 38	10 x 38
Operational current Ie/400 V	2 A	4 A	4 A	6 A	8 A	12 A	16 A
Thermal overload relay cI10A	LR2K0306	LR2K0308	LR2K0310	LR2K0312	LR2K0314	LR2K0316	LR2K0321
TeSys H ultra-compact motor starter							
Breaking capacity Icu/400 V	> 100 KA	> 100 KA	> 100 KA	> 100 KA	> 100 KA	> 100 KA	> 100 KA
Magnetic circuit breaker	GV2L06	GV2L07	GV2L08	GV2L10	GV2L14		
Rotary handle							
Breaking capacity Icu/400 V	> 100 KA	> 100 KA	> 100 KA	> 100 KA	> 100 KA	> 100 KA	> 100 KA
Magnetic circuit breaker	GV2LE06	GV2LE07	GV2LE08	GV2LE10	GV2LE14		
Tumbler control							
Ultra-compact starter							
Standard version	LZ1H2X...	LZ1H2X...	LZ1H6X...	LZ1H6X...	LZ1H6X...		
"Safety" version	LZ7H2X...	LZ7H2X...	LZ7H6X...	LZ7H6X...	LZ7H6X...		

(1) Naming rule for the TeSys K range: LC1K... for AC; LP1K... for DC; LP4K... for DC < 2.4 V. For more details, please refer to the TeSys catalog.

(2) The end of the product references must be replaced with a coil voltage code as indicated above (eg.: "P7" for 230 VAC, "BD" for 24 VDC). For more details, please refer to the TeSys catalog.

TeSys Universal

Build your motor starter!

	Contactor	Thermal-magnetic circuit breaker	Magnetic circuit breaker	Switch-disconnector fuse	Thermal overload relay	Compact starter controller
Range name	TeSys K, TeSys Deca & Giga	TeSys GV.ME/P	TeSys GV.L	TeSys GS	TeSys K, TeSys Deca & Giga	TeSys Ultra
Product reference prefix	LC	GV	GV.L	GS	LR	LU
Motor starter structure - 4 functions to be covered:						
 Disconnection and breaking	■	■	■	■	■	■
 Short-circuit protection	■	■	■	■	■	■
 Overload protection	■	■	■	■	■	■
 Control	■	■	■	■	■	■

3

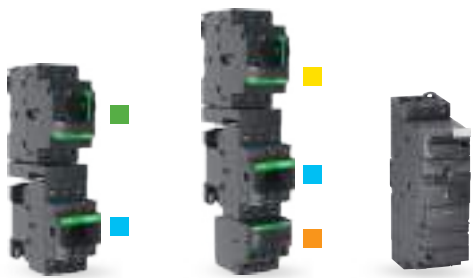

Voltage coil code





	■ ■	■ ■	■ ■	■ ■	★ ★
	AC	DC	DC < 2.4 W	AC/DC	AC/DC
24 V	B7	BD	BL	BNE	B/BL
48 V	E7	ED	EL	BNE	ES
110 V	F7	FD		KUE	FU
220 V	M7			KUE	FU
230 V	P7			KUE	FU

Motor power AC3 380/400 V	0.37...0.55 kW	0.75 kW	1.1...1.5 kW	2.2 kW	3 kW	4 kW
TeSys Deca Contactors						
le max. AC3 (Ue ≤ 440 V)	9 A	9 A	9 A	9 A	9 A	9 A
le AC1 (T < 60°C)	25 A	25 A	25 A	25 A	25 A	25 A
Contactor (1)	LC1D09 ■ ■	LC1D09 ■ ■	LC1D09 ■ ■	LC1D09 ■ ■	LC1D09 ■ ■	LC1D09 ■ ■
Breaking capacity Icu/400 V	100 KA	100 KA	100 KA	100 KA	100 KA	100 KA
Thermal-magnetic circuit breaker	GV2P06	GV2P07	GV2P08	GV2P10	GV2P14	GV2P14
Rotary handle						
Breaking capacity Icu/400 V	100 KA	100 KA	100 KA	100 KA	100 KA	100 KA
Thermal-magnetic circuit breaker	GV2ME06	GV2ME07	GV2ME08	GV2ME10	GV2ME14	GV2ME14
Pushbutton control						
Breaking capacity Icu/400 V	100 KA	100 KA	100 KA	100 KA	100 KA	100 KA
Magnetic circuit breaker	GV2LE06	GV2LE07	GV2LE08	GV2LE10	GV2LE14	GV2LE14
Tumbler control						
Breaking capacity Icu/400 V	100 KA	100 KA	100 KA	100 KA	100 KA	100 KA
Magnetic circuit breaker	GV2L06	GV2L07	GV2L08	GV2L10	GV2L14	GV2L14
Rotary handle						
Switch-disconnector fuse	GS1DD	GS1DD	GS1DD	GS1DD	GS1DD	GS1DD
Fuse type	10 x 38	10 x 38	10 x 38	10 x 38	10 x 38	10 x 38
Operational current Ie/400 V	2 A	4 A	4 A	6 A	8 A	12 A
Thermal overload relay cI10A	LRD06	LRD07	LRD08	LRD10	LRD12	LRD14
Thermal overload relay cI20	-	-	LRD1508	LRD1510	LRD1512	LRD1514
TeSys Ultra Compact Motor Starter						
Breaking capacity Icu/400 V	50 kA	50 kA	50 kA	50 kA	50 kA	50 kA
Power base	LUB12	LUB12	LUB12	LUB12	LUB12	LUB12
Control unit	LUCA1X ★ ★	LUCA05 ★ ★	LUCA05 ★ ★	LUCA12 ★ ★	LUCA12 ★ ★	LUCA12 ★ ★
LAD5C... and LAD9AP3... modules provide pre-wired solutions for GV + LC1D control circuits. Use LUF00 for TeSys Ultra.						

(1) The end of the product references must be replaced with a coil voltage code as indicated above (eg.: "P7" for 230 VAC, "BD" for 24 VDC). For more details, please refer to the TeSys catalog.

TeSys Universal

Build your motor starter!

	Contactor	Thermal-magnetic circuit breaker	Magnetic circuit breaker	Switch-disconnector fuse	Thermal overload relay	Compact starter controller
Range name	TeSys K, TeSys Deca & Giga	TeSys GV.ME/P	TeSys GV.L	TeSys GS	TeSys K, TeSys Deca & Giga	TeSys Ultra
Product reference prefix	LC	GV	GV.L	GS	LR	LU
Motor starter structure - 4 functions to be covered:						
 Disconnection and breaking	■	■	■	■	■	■
 Short-circuit protection	■	■	■	■	■	■
 Overload protection	■	■	■	■	■	■
 Control	■	■	■	■	■	■

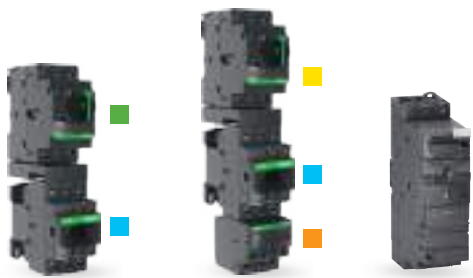

Voltage coil code

	■ ■	■ ■	■ ■	■ ■	★ ★
	AC	DC	DC < 2.4 W	AC/DC	AC/DC
24 V	B7	BD	BL	BNE	B/BL
48 V	E7	ED	EL	BNE	ES
110 V	F7	FD		KUE	FU
220 V	M7			KUE	FU
230 V	P7			KUE	FU







Motor power AC3 380/400 V	5.5 kW	7.5 kW	9 kW	11 kW	15 kW	18.5 kW
TeSys Deca Contactors						
le max. AC3 (Ue ≤ 440 V)	12 A	18 A	25 A	25 A	32 A	
le AC1 (T < 60°C)	25 A	32 A	40 A	40 A	50 A	
Contactor (1)	LC1D12 ■ ■	LC1D18 ■ ■	LC1D25 ■ ■	LC1D25 ■ ■	LC1D32 ■ ■	
Breaking capacity Icu/400 V	100 KA	100 KA	100 KA	100 KA	100 KA	
Thermal-magnetic circuit breaker	GV2P16	GV3P18	GV3P25	GV3P25	GV3P32	
Rotary handle						
Breaking capacity Icu/400 V	15 KA	15 KA	15 KA	15 KA	15 KA	
Thermal-magnetic circuit breaker	GV2ME16	GV2ME20	GV2ME21	GV2ME22	GV2ME32	
Pushbutton control						
Breaking capacity Icu/400 V	15 KA	15 KA	15 KA	15 KA	15 KA	
Magnetic circuit breaker	GV2LE16	GV2LE20	GV2LE22	GV2LE22	GV2LE32	
Tumbler control						
Breaking capacity Icu/400 V	100 KA	100 KA	100 KA	100 KA	100 KA	
Magnetic circuit breaker	GV2L16	GV2L20	GV2L22	GV3L25	GV3L32	
Rotary handle						
Switch-disconnector fuse	GS1DD	GS1DD	GS1DD	GS1DD	GS1DD	
Fuse type	10 x 38	10 x 38	10 x 38	10 x 38	10 x 38	
Operational current Ie/400 V	16 A	16 A	25 A	25 A	32 A	
Thermal overload relay cI10A	LRD16	LRD21	LRD22	LRD22	LRD32	
	-	-	-	LRD325 (2)	LRD332 (2)	
Thermal overload relay cI20	LRD1516	LRD1521	LRD1522	LRD1522	LRD1532	
	-	-	-	LRD325L (2)	LRD332L (2)	
TeSys Ultra Compact Motor Starter						
Breaking capacity Icu/400 V	50 kA	50 kA	50 kA	50 kA	50 kA	25 kA
Power base	LUB12	LUB32	LUB32	LUB32	LUB32	LUB38
Control unit	LUCA12 ★ ★	LUCA18 ★ ★	LUCA32 ★ ★	LUCA32 ★ ★	LUCA32 ★ ★	LUCA38 ★ ★
LAD5C.. and LAD9AP3.. modules provide pre-wired solutions for GV + LC1D control circuits. Use LUFC00 for TeSys Ultra.						

(1) The end of the product references must be replaced with a coil voltage code as indicated above (eg.: "P7" for 230 VAC, "BD" for 24 VDC). For more details, please refer to the TeSys catalog.
 (2) BTR screws (EverLink).

TeSys Universal

Build your motor starter!

	Contactor	Thermal-magnetic circuit breaker	Magnetic circuit breaker	Switch-disconnector fuse	Thermal overload relay
Range name	TeSys D, TeSys Deca & Giga	TeSys GV	TeSys GV.L	TeSys GS	TeSys D, TeSys Deca & Giga
Product reference prefix	LC	GV	GV.L	GS	LR
Motor starter structure - 4 functions to be covered:					
 Disconnection and breaking	■	■	■	■	■
 Short-circuit protection	■	■	■	■	■
 Overload protection	■	■	■	■	■
 Control	■	■	■	■	■

3

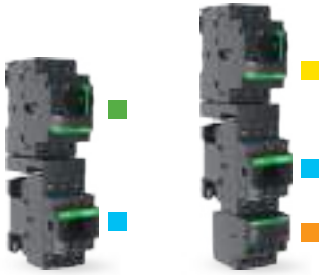

Voltage coil code

	■ ■	■ ■	■ ■	■ ■	■ ■	● ●	● ●
	AC	DC	DC < 2.4 W	AC/DC	DC < 0.5 W	AC	DC
24 V	B7	BD	BL	BNE	BBE	B7	BD
48 V	E7	ED	EL	BNE		E7	ED
110 V	F7	FD		KUE		F7	FD
220 V	M7			KUE		M7	
230 V	P7			KUE		P7	





Motor power AC3 380/400 V	18.5 kW	22 kW	30 kW	37 kW	45 kW	55 kW	75 kW
TeSys Deca Contactors							
le max. AC3 (Ue ≤ 440 V)	40 A	50 A	65 A	80 A	95 A	115 A	150 A
le AC1 (T < 60°C)	60 A	80 A	80 A	125 A	125 A	200 A	200 A
Contactor (1)	LC1D40A ■ ■	LC1D50A ■ ■	LC1D65A ■ ■	LC1D80A ■ ■	LC1D95 ● ●	LC1D115 ● ●	LC1D150 ● ● / LC1F150 ● ●
Breaking capacity Icu/400 V	50 KA	50 KA	50 KA	100 KA	100 KA	100 KA	70 KA
Thermal-magnetic circuit breaker	GV3P40	GV3P50	GV3P65	GV4P80	GV4P115	GV4P115	GV5P150H
	Rotary handle			Rotary or tumbler handle		Rotary handle	
Breaking capacity Icu/400 V	50 KA	50 KA	50 KA	50 KA	100 KA	100 KA	36 KA
Thermal-magnetic circuit breaker	GV3P40	GV3P50	GV3P65	GV3P73	GV4P115	GV4P115	GV5P150F
	Rotary handle			Rotary or tumbler handle		Rotary handle	
Breaking capacity Icu/400 V	50 KA	50 KA	50 KA	100 KA	100 KA	100 KA	70 KA
Magnetic circuit breaker	GV3L40	GV3L50	GV3L65	GV4L80	GV4L115	GV4L115	NSX160HMA
	Rotary handle			Rotary or tumbler handle			
Breaking capacity Icu/400 V	50 KA	50 KA	50 KA	50 KA	100 KA	100 KA	50 KA
Magnetic circuit breaker	GV3L40	GV3L50	GV3L65	GV3L73	GV4L115	GV4L115	NSX160NMA
	Rotary handle			Rotary or tumbler handle			
Switch-disconnector fuse	GS2F	GS2F	GS2J	GS2J	GS2J	GS2J	GS2J GS2LL GS2L
Fuse type	14 x 51	14 x 51	22 x 58	22 x 58	22 x 58	22 x 58	T00 T0
Operational current Ie/400 V	40 A	50 A	80 A	100 A	100 A	125 A	160 A
Thermal overload relay cI10A	-	-	-	LRD3361	LRD3365	LRD4367	LRD4369
	LRD340	LRD350	LRD365	-	-	LR9D5369 (2)	LR9D5369 (2)
Thermal overload relay cI20	LRD340L	LRD350L	LRD365L	LR2D3563	-	LR9D5569 (2)	LR9D5569 (2)

(1) The end of the product references must be replaced with a coil voltage code as indicated above (eg.: "P7" for 230 VAC, "BD" for 24 VDC). For more details, please refer to the TeSys catalog.

(2) Electronic products.

TeSys Universal

Build your motor starter!

	Contactor	Thermal-magnetic circuit breaker	Magnetic circuit breaker	Switch-disconnector fuse	Thermal overload relay
Range name	TeSys K, TeSys Deca & Giga	TeSys GV5/GV6, ComPacT NSX/NS	ComPacT NSX/NS	TeSys GS	TeSys K, TeSys Deca & Giga
Product reference prefix	LC	GV.P/LV4/33	GV.L	GS	LR
Motor starter structure - 4 functions to be covered:					
 Disconnection and breaking	<input type="checkbox"/>	<input checked="" type="checkbox"/>	<input checked="" type="checkbox"/>	<input checked="" type="checkbox"/>	<input type="checkbox"/>
 Short-circuit protection	<input type="checkbox"/>	<input checked="" type="checkbox"/>	<input checked="" type="checkbox"/>	<input checked="" type="checkbox"/>	<input type="checkbox"/>
 Overload protection	<input type="checkbox"/>	<input checked="" type="checkbox"/>	<input type="checkbox"/>	<input type="checkbox"/>	<input checked="" type="checkbox"/>
 Control	<input checked="" type="checkbox"/>	<input type="checkbox"/>	<input type="checkbox"/>	<input type="checkbox"/>	<input type="checkbox"/>

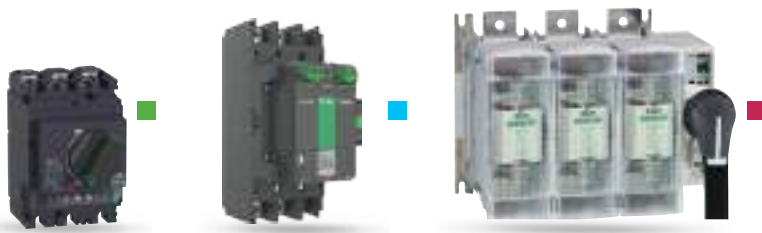

TeSys Giga Contactor LC1G115...LC1G800	Advanced Version	Standard Version
Control Voltage code (●●●)	LC1G.....A	LC1G.....N
24...48 V AC/DC	BEE*	-
48...130 V AC/DC	EHE	EHE
100...250 V AC/DC	-	KUE
200...500 V AC/DC	LSE	-
*LC1G115-LC1G500		

TeSys F Contactor LC1F1000	AC	DC
110 V	F7	FD
220 V	M7	MD
230 V	M7	
240 V	U7	

3

Motor power AC3 400 V	55 kW	75 kW	90 kW	110 kW	132 kW	160 kW	200 kW	250 kW	335 kW	450 kW	500 kW
-----------------------	-------	-------	-------	--------	--------	--------	--------	--------	--------	--------	--------

	TeSys Giga contactor										
Ie max. AC3 (Ue ≤ 440 V)	115 A	150 A	185 A	225 A	265 A	330 A	400 A	500 A	630 A	800 A	1000 A
Ie AC1 (T < 60°C)	250 A	275 A	305 A	330 A	385 A	440 A	550 A	700 A	1050 A	1050 A	1250 A (2)
Contactor (1)	LC1G115●●●	LC1G150●●●	LC1G185●●●	LC1G225●●●	LC1G265●●●	LC1G330●●●	LC1G400●●●	LC1G500●●●	LC1G630●●●	LC1G800●●●	LC1F1000●●

2 devices: Type-2 protection

Breaking capacity Icu/400 V	70 kA	70 kA	70 kA	70 kA	70 kA	70 kA	70 kA	70 kA	70 kA	70 kA	70 kA
Thermal-magnetic circuit breaker	GV5P150H	GV5P150H	GV5P220H	GV5P220H	GV6P320H	GV6P320H	GV6P500H	GV6P500H	NS800H	NS800H/NS1000H	NS1000L
Trip unit	Micrologic 2.2M	Micrologic 2.2M	Micrologic 2.2M	Micrologic 2.2M	Micrologic 2.2M	Micrologic 2.2M	Micrologic 2.2M	Micrologic 2.2M	Micrologic 5.0	Micrologic 5.0	Micrologic 5.0
Breaking capacity Icu/400 V	36 kA	36 kA	36 kA	36 kA	36 kA	36 kA	36 kA	36 kA	50 kA	50 kA	42 kA
Thermal-magnetic circuit breaker	GV5P150F	GV5P150F	GV5P220F	GV5P220F	GV6P320F	GV6P320F	GV6P500F	GV6P500F	NS800N	NS800N	NS1000L
Trip unit	Micrologic 2.2M	Micrologic 2.2M	Micrologic 2.2M	Micrologic 2.2M	Micrologic 2.2M	Micrologic 2.2M	Micrologic 2.2M	Micrologic 2.2M	Micrologic 5.0	Micrologic 5.0	Micrologic 5.0

3 devices: Type-2 protection

Breaking capacity Icu/ 400 V	70 kA	70 kA	70 kA	70 kA	70 kA	70 kA	70 kA	70 kA	130 kA	130 kA	130 kA
Magnetic circuit breaker	NS160H	NS160H	NSX250H	NSX250H	NSX400H	NSX400H	NSX630H	NSX630H	NS800L	NS800L	NS1000L
Trip unit	MA	MA	MA	MA	Micrologic 1.3-M	Micrologic 1.3-M	Micrologic 1.3-M	Micrologic 1.3-M	(3)	(3)	(3)
Overload relay (4)	LR9G225	LR9G225	LR9G225	LR9G225	LR9G500	LR9G500	LR9G500	LR9G500	LR9G500	-	LRD05 + Current transformer 800/1 A
Breaking capacity Icu/ 400 V	50 kA	50 kA	50 kA	50 kA	50 kA	50 kA	50 kA	50 kA	130 kA	130 kA	130 kA
Magnetic circuit breaker	NS160N	NS160N	NSX250N	NSX250N	NSX400N	NSX400N	NSX630N	NSX630N	NS800L	NS800L	NS1000L
Trip unit	MA	MA	MA	MA	Micrologic 1.3-M	Micrologic 1.3-M	Micrologic 1.3-M	Micrologic 1.3-M	(3)	(3)	(3)
Overload relay (4)	LR9G225	LR9G225	LR9G225	LR9G225	LR9G500	LR9G500	LR9G500	LR9G500	LR9G500	-	LRD05 + Current transformer 800/1 A (5)
Breaking capacity Icu/ 400 V	80 kA	80 kA	80 kA	80 kA	80 kA	80 kA	80 kA	80 kA	80 kA	80 kA	80 kA
Switch-disconnector fuse	GS2L	GS2L	GS2N	GS2N	GS2N	GS2QQ	GS2S	GS2S	GS2S	GS2S	GS2V
Fuse size (type DIN - aM fuses)	0	0	1	1	2	2	3	3	4	4	4
Operational current Ie/ 400 V	125 A	160 A	200 A	250 A	315 A	400 A	500 A	500 A	800 A	800 A	1000 A
Overload relay (4)	LR9G115	LR9G225	LR9G225	LR9G225	LR9G500	LR9G500	LR9G500	LR9G500	LR9G630	LRD10 + current transformer 5A/5VA (5)	LRD10 + current transformer 5A/5VA (5)

(1) Contactor references must be completed with coil voltage code as indicated above table (eg.: "LSE" for 200...500V AC/DC control voltage) and ended with A for Advanced version and N for Standard version. For more details, please refer to the TeSys Giga catalog.

(2) 1250 A at 40 °C.





(3) Micrologic 5.0 + Plug LR Off.

(4) LR9G- Electronic thermal over-load relay with trip class selection from 5e...30e with phase imbalance and ground fault protections.

(5) Thermal overload relay class 10 A

TeSys Universal

Build your motor starter!

	Main/Emergency stop switch-disconnector	Fuse carrier	Control relay
Range name	TeSys Vario	TeSys DF	TeSys CAD, CAK
Product reference prefix	V	DF	CAD, CAK
Motor starter structure - 4 functions to be covered:			
 Disconnection and breaking	■	■	■
 Short-circuit protection	■	■	■
 Overload protection	■	■	■
 Control	■	■	■

3



TeSys Vario		Application	Standard	High performance									
				Ith (A)	12	20	12	20	25	32	40	63	80
Main switch disconnector	Door mounting	D22 fixing	VBDN12	VBDN20	VBD02	VBD01	VBD0	VBD1	VBD2	–	–	–	–
		Screw fixing	–	–	VBF02	VBF01	VBF0	VBF1	VBF2	VBF3	VBF4	VBF5	VBF6
Emergency stop switch disconnector	Door mounting	D22 fixing	VCDN12	VCDN20	VCD02	VCD01	VCD0	VCD1	VCD2	–	–	–	–
		Screw fixing	–	–	VCF02	VCF01	VCF0	VCF1	VCF2	VCF3	VCF4	VCF5	VCF6
	Back mounting	D22 fixing	VCCDN12	VCCDN20	VCCD02	VCCD01	VCCD0	VCCD1	VCCD2	–	–	–	–
		Screw fixing	–	–	VCCF02	VCCF01	VCCF0	VCCF1	VCCF2	VCCF3	VCCF4	VCCF5	VCCF6



TeSys DF fuse carrier					
Fuse type		8x32	10x38	14x51	22x58
Fuse carrier	1 pole	DF81	DF101	DF141	DF221
	2 poles	DF82	DF102	DF142	DF222
	3 poles	DF83	DF103	DF143	DF223
Thermal current Ith (A)		25	32	50	125



TeSys Control relay				
Auxiliary contact		AC control coil	DC control coil	DC control coil low consumption
NO	NC	4.5 VA	3 W	1.8 W
4	–	CA2KN40●●	CA3KN40●●	CA3KN40BW3
3	1	CA2KN31●●	CA3KN31●●	CA3KN31BW3
2	2	CA2KN22●●	CA3KN22●●	CA3KN22BW3
		8 VA	5.4 W	2.4 W
5	–	CAD50●●		
3	2	CAD32●●		

Voltage coil code

	AC	DC	DC < 2.4 W
24 V	B7	BD	BL
48 V	E7	ED	EL
110 V	F7	FD	FL
220 V	M7		
230 V	P7		

Distribution system protection

Compact NSXm molded-case circuit breakers and switch-disconnectors up to 160 A and 70 kA at 415 V



For breaking capacity, replace • with: 1 (16 kA at 380/415 V), 2 (25 kA at 380/415 V), 3 (36 kA at 380/415 V), 4 (50 kA at 380/415 V), or 5 (70 kA at 380/415 V).

Compact NSXm circuit breaker

With thermal-magnetic trip unit TM-D

EverLink™ connectors

Rating	Trip unit	3P	4P 3d	4P 4d
16 A	TM16D	LV426•00	LV426•10	LV426•20
25 A	TM25D	LV426•01	LV426•11	LV426•21
32 A	TM32D	LV426•02	LV426•12	LV426•22
40 A	TM40D	LV426•03	LV426•13	LV426•23
50 A	TM50D	LV426•04	LV426•14	LV426•24
63 A	TM63D	LV426•05	LV426•15	LV426•25
80 A	TM80D	LV426•06	LV426•16	LV426•26
100 A	TM100D	LV426•07	LV426•17	LV426•27
125 A	TM125D	LV426•08	LV426•18	LV426•28
160 A	TM160D	LV426•09	LV426•19	LV426•29

Compact NSXm NA switch-disconnector

EverLink™ connectors

Rating	3P	4P
50 A	LV426600	LV426610
100 A	LV426601	LV426611
160 A	LV426602	LV426612

Note: For accessories and more details, please refer to the NSXm catalog.

PowerPact B molded-case circuit breakers up to 125 A and 65 kA at 480 V



PowerPact B-Frame 125 A unit-mount thermal-magnetic circuit breakers (480 VAC) Delta rated

With factory sealed trip unit (suitable for reverse connection)

B-Frame, 125 A, 3P, 480 VAC 50/60 Hz with EverLink™ connectors

Current rating at 40 °C (A)	Fixed AC magnetic trip (A)		Interrupting rating standard (80%) rated		
	Hold	Trip	D - 18 kA	G - 35 kA	J - 65 kA
15	400	600	BDL36015LU	BGL36015LU	BJL36015LU
20	400	600	BDL36020LU	BGL36020LU	BJL36020LU
25	400	600	BDL36025LU	BGL36025LU	BJL36025LU
30	400	600	BDL36030LU	BGL36030LU	BJL36030LU
35	400	600	BDL36035LU	BGL36035LU	BJL36035LU
40	400	600	BDL36040LU	BGL36040LU	BJL36040LU
45	400	600	BDL36045LU	BGL36045LU	BJL36045LU
50	480	720	BDL36050LU	BGL36050LU	BJL36050LU
60	640	960	BDL36060LU	BGL36060LU	BJL36060LU
70	640	960	BDL36070LU	BGL36070LU	BJL36070LU
80	800	1200	BDL36080LU	BGL36080LU	BJL36080LU
90	1000	1500	BDL36090LU	BGL36090LU	BJL36090LU
100	1000	1500	BDL36100LU	BGL36100LU	BJL36100LU
110	1000	1500	BDL36110LU	BGL36110LU	BJL36110LU
125	1000	1500	BDL36125LU	BGL36125LU	BJL36125LU

Note: For accessories and more details, please refer to the PowerPact B catalog.

Distribution system protection

Multi 9 miniature circuit breakers

Feeder products - C60BP - UL 489 - Z, C, D curves – Tunnel terminals



Main characteristics

Number of 18 mm/0.71 in. poles	Rating (A) 25 °C/77 °F	Breaking capacity (kA rms) AIR UL 489/CSA C22.2 No 5				Icu IEC 60947 - 2			
		277 V~	240 V~	120 V~	60 V ∴	440 V~	415 V~	240 V~	60 ∴
Poles	Voltage (Ue)								
1P	0.5 to 35	10	14	14	10	–	3	10	20
	40 to 63	–	10	10	10	–	3	10	20
Poles	Voltage (Ue)	480Y/277 V~		240 V~	125 V ∴	440 V~	415 V~	240 V~	125 ∴
2P	1 to 25	10		14	10	6	10	20	–
	30 to 35	10		14	–	6	10	20	–
3P	1 to 35	10		14	–	6	10	20	–
2P/3P	40 to 63	–		10	–	6	10	20	–

Tunnel terminal connection

Type	UL489 and CSA voltages	1P			2P		3P	
Auxiliaries		Remote indication and tripping						
Rating (In)		Curve			Curve		Curve	
		Z	C	D (=K)	C	D (=K)	C	D (=K)
C60 _{SP}								
0.5	480 Y/277 V and 240 V	M9F44170	M9F42170	M9F43170	–	–	–	–
1		M9F44101	M9F42101	M9F43101	M9F42201	M9F43201	M9F42301	M9F43301
2		M9F44102	M9F42102	M9F43102	M9F42202	M9F43202	M9F42302	M9F43302
3		M9F44103	M9F42103	M9F43103	M9F42203	M9F43203	M9F42303	M9F43303
4		M9F44104	M9F42104	M9F43104	M9F42204	M9F43204	M9F42304	M9F43304
5		M9F44105	M9F42105	M9F43105	M9F42205	M9F43205	M9F42305	M9F43305
6		M9F44106	M9F42106	M9F43106	M9F42206	M9F43206	M9F42306	M9F43306
8		M9F44108	M9F42108	M9F43108	M9F42208	M9F43208	M9F42308	M9F43308
10		M9F44110	M9F42110	M9F43110	M9F42210	M9F43210	M9F42310	M9F43310
15		M9F44115	M9F42115	M9F43115	M9F42215	M9F43215	M9F42315	M9F43315
20		M9F44120	M9F42120	M9F43120	M9F42220	M9F43220	M9F42320	M9F43320
25		M9F44125	M9F42125	M9F43125	M9F42225	M9F43225	M9F42325	M9F43325
30		M9F44130	M9F42130	M9F43130	M9F42230	M9F43230	M9F42330	M9F43330
35		M9F44135	M9F42135	M9F43135	M9F42235	M9F43235	M9F42335	M9F43335
40	240 V only	M9F44140	M9F42140	M9F43140	M9F42240	M9F43240	M9F42340	M9F43340
45		M9F44145	M9F42145	M9F43145	M9F42245	M9F43245	M9F42345	M9F43345
50		M9F44150	M9F42150	M9F43150	M9F42250	M9F43250	M9F42350	M9F43350
63		M9F44163	M9F42163	M9F43163	M9F42263	M9F43263	M9F42363	M9F43363

Note: For accessories and more details, please refer to the Multi9 catalog.

In order to check the availability of the Multi9 range in your country, please contact your local Schneider Electric representative. Except for the US market, use of the Acti9 range is still possible.

3

Distribution system protection

Multi 9 miniature circuit breakers

Supplementary protection products - C60SP - UL 1077 - B, C, D curves – Tunnel terminals



Main characteristics

Number of 18 mm/0.71 in. poles	Rating (A) 25 °C/77 °F	Breaking capacity (kA rms) AIR UL 1077/CSA C22.2 No 235				Icu IEC 60947 - 2			
		277 V~	240 V~	120 V~	65 V ∴	440 V~	415 V~	240 V~	60 ∴
Poles	Voltage (Ue)								
1P	0.5 to 32	10	14	14	10	–	3	10	20
	40 to 63	5	10	10	10	–	3	10	20
Poles	Voltage (Ue)	480Y/277 V~		240 V~	125 V ∴	440 V~	415 V~	240 V~	125 ∴
2P	1 to 25	10		14	10	6	10	20	–
	32	10		14	–	6	10	20	–
3P/4P	2 to 32	10		14	–	6	10	20	–
2P/3P/4P	40 to 63	5		10	–	6	10	20	–

Tunnel terminal connection

Type	1P			2P			3P			4P		
Auxiliaries	Remote indication and tripping											
Rating (In)	Curve			Curve			Curve			Curve		
	B	C	D (=K)	Curve B	C	D (=K)	B	C	D (=K)	B	C	D (=K)
C60 _{SP}												
0.5	M9F21170	M9F22170	M9F23170	–	–	–	–	–	–	–	–	–
1	M9F21101	M9F22101	M9F23101	M9F21201	M9F22201	M9F23201	–	–	–	–	–	–
2	M9F21102	M9F22102	M9F23102	M9F21202	M9F22202	M9F23202	M9F21302	M9F22302	M9F23302	M9F21402	M9F22402	M9F23402
3	M9F21103	M9F22103	M9F23103	M9F21203	M9F22203	M9F23203	–	–	–	–	–	–
4	M9F21104	M9F22104	M9F23104	M9F21204	M9F22204	M9F23204	–	–	–	–	–	–
5	M9F21105	M9F22105	M9F23105	M9F21205	M9F22205	M9F23205	–	–	–	–	–	–
6	M9F21106	M9F22106	M9F23106	M9F21206	M9F22206	M9F23206	M9F21306	M9F22306	M9F23306	M9F21406	M9F22406	M9F23406
8	M9F21108	M9F22108	M9F23108	M9F21208	M9F22208	M9F23208	M9F21308	M9F22308	M9F23308	M9F21408	M9F22408	M9F23408
10	M9F21110	M9F22110	M9F23110	M9F21210	M9F22210	M9F23210	M9F21310	M9F22310	M9F23310	M9F21410	M9F22410	M9F23410
13	M9F21113	M9F22113	M9F23113	M9F21213	M9F22213	M9F23213	M9F21313	M9F22313	M9F23313	M9F21413	M9F22413	M9F23413
16	M9F21116	M9F22116	M9F23116	M9F21216	M9F22216	M9F23216	M9F21316	M9F22316	M9F23316	M9F21416	M9F22416	M9F23416
20	M9F21120	M9F22120	M9F23120	M9F21220	M9F22220	M9F23220	M9F21320	M9F22320	M9F23320	M9F21420	M9F22420	M9F23420
25	M9F21125	M9F22125	M9F23125	M9F21225	M9F22225	M9F23225	M9F21325	M9F22325	M9F23325	M9F21425	M9F22425	M9F23425
32	M9F21132	M9F22132	M9F23132	M9F21232	M9F22232	M9F23232	M9F21332	M9F22332	M9F23332	M9F21432	M9F22432	M9F23432
40	M9F21140	M9F22140	M9F23140	M9F21240	M9F22240	M9F23240	M9F21340	M9F22340	M9F23340	M9F21440	M9F22440	M9F23440
45	M9F21145	M9F22145	M9F23145	M9F21245	M9F22245	M9F23245	M9F21345	M9F22345	M9F23345	M9F21445	M9F22445	M9F23445
50	M9F21150	M9F22150	M9F23150	M9F21250	M9F22250	M9F23250	M9F21350	M9F22350	M9F23350	M9F21450	M9F22450	M9F23450
63	M9F21163	M9F22163	M9F23163	M9F21263	M9F22263	M9F23263	M9F21363	M9F22363	M9F23363	M9F21463	M9F22463	M9F23463

Note: For accessories and more details, please refer to the Multi9 catalog.

In order to check the availability of the Multi9 range in your country, please contact your local Schneider Electric representative. Except for the US market, use of the Acti9 range is still possible.

Distribution system protection

Multi 9 miniature circuit breakers

Ground fault protector (GFP) UL1053 & IEC/EN 61008

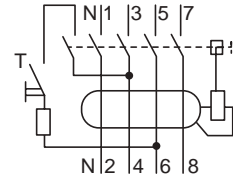
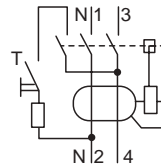

GFP UL 1053 type A-SI

Supported standards	UL, IEC		2P		4P		
A-SI type	Rating (A)	Sensitivity (mA)		Reference		Reference	
		UL 1053	IEC / EN 61008	120 or 240 V 230 or 240 V	240 V 480 V / 277 V 230 / 400 or 240 / 415 V	120 or 240 V 230 or 240 V	240 V 480 V / 277 V 230 / 400 or 240 / 415 V
	A	mA	mA				
25	25	26	30	M9R81225	M9R41225	–	M9R81425
		86	100	M9R12225	M9R44225	–	M9R12425
		260	300	M9R84225	–	–	M9R84425
40	40	26	30	M9R81240	M9R41240	–	M9R81440
		260	300	M9R84240	–	–	M9R84440
63	63	26	30	M9R81263	–	–	M9R81463
		86	100	–	–	–	M9R12463
100	100	86	100	–	–	–	M9R12491
		260	100	–	–	–	M9R84491

3

Residual current circuit breakers (RCCB) ID - IEC/EN 61008-1

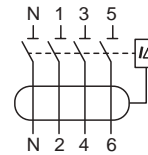
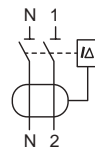

RCCB - ID residual current circuit breakers

Type	AC	A - SI			
Auxiliaries	2P				
	Sensitivity	30 mA	300 mA	30 mA	300 mA
	25 A	M9R11225	–	–	–
	40 A	M9R11240	M9R14240	M9R31240	M9R35240
Voltage rating (Ue)		230-240 V, 50 Hz			
Auxiliaries	4P				
	40 A	M9R11440	M9R14440	M9R31440	M9R35440
	63 A	M9R11463	M9R1463	M9R31463	M9R35463
Voltage rating (Ue)		400 - 415 V, 50 Hz			

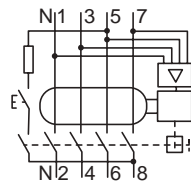

Acti9 iID B-SI type residual current circuit breakers

Type	B-SI					
4P	Rating (A)	Sensitivity	30 mA	300 mA	300 mA	500 mA
	25	B-SI	A9Z61425	A9Z64425	–	–
	40	B-SI	A9Z61440	A9Z64440	A9Z65440	A9Z66440
	63	B-SI	A9Z61463	A9Z64463	A9Z65463	A9Z66463
	40	B-SI	A9Z61480	A9Z64480	A9Z65480	A9Z66480
	125	B	16763	16764	16765	16766
Voltage rating (Ue)	230/400 V					
Operating frequency	50 Hz					

Note: For accessories and more details, please refer to the Multi9 catalog.

In order to check the availability of the Multi9 range in your country, please contact your local Schneider Electric representative. Except for the US market, use of the Acti9 range is still possible.

Distribution system protection

Power metering and control

PowerTag and wireless energy sensor modules

IEC



PowerTag Energy 63 A

Pole	Design	Type of mounting	Reference
1P + wire	Monoconnect	Top and Bottom	A9MEM1520
1P + N	Monoconnect	Top	A9MEM1521
	Monoconnect	Bottom	A9MEM1522
	Flex	Top and Bottom	A9MEM1560
3P	Monoconnect	Top and Bottom	A9MEM1540
	Flex	Top and Bottom	A9MEM1573 (1)
3P + N	Monoconnect	Top	A9MEM1541
	Monoconnect	Bottom	A9MEM1542
	Flex	Top and Bottom	A9MEM1570

PowerTag Energy Monoconnect 250/630 A

Pole	Rating	Reference
3P	250 A	LV434020 (2)
	630 A	LV434022 (3)
3P + N	250 A	LV434021
	630 A	LV434023



PowerTag Energy Flex 160 A

Pole	Rating	Reference
3P/3P + N	160 A	A9MEM1580

- (1) Suitable with TeSys LC1D and GV<63A
- (2) Suitable with GV5
- (3) Suitable with GV6

PowerTag Energy Rope up to 2000 A

Pole	Rating	Reference
3P/3P + N	200 A	A9MEM1590
	600 A	A9MEM1591
	1000 A	A9MEM1592
	2000 A	A9MEM1593

IEC



Main characteristics of EcoStruxure Panel Server (Ethernet)

Application	Metering and monitoring solutions	
Communication type	Radio frequency and Modbus RS485	
Number of connected sensors	Entry Panel Server	Up to 20 wireless devices
	Universal Panel Server	Up to 100 wireless devices, and Up to 32 Modbus RS485
	Devices Without Repeater	Up to 128 Modbus RS485 without repeater

Ecostruxure Panel server

Type	Set	Reference
Entry Panel Server	1	PAS400
Universal Panel Server	1	PAS600L (24VDC Power supply)
		PAS600T (110 - 240 V AC/DC Power Supply)
		PAS600 (110 - 270 V AC/DC Power Supply)

Note: For accessories and more details, please refer to the PowerTag and Panel Server catalogs.

Energy meter and power meter



Energy meter

Type of network	1P+N	1P+N	1P+N, 3P, 3P+N
Self-powered	Yes	Yes	Yes
Display	1 line	1 line	3 lines
Width (mm)	17.5	36	90
Current input	45 A	63 A	63 A
Multi tariff	2	-	-
Communication	Modbus RS485	Modbus RS485	Modbus RS485
Active Energy accuracy	Cl 1	Cl 1	Cl 1
I/O	1 Pulse O	-	-
Reference	A9MEM2050	A9MEM2150	A9MEM3150

Note: For more details, please refer to the PowerLogic catalog

Power meter

Type of network	1P+N, 3P, 3P+N	1P+N, 3P, 3P+N	1P+N, 3P, 3P+N
Self-powered	No	No	No
Display	6 lines	6 lines	6 lines
Width (mm)	96	96	96
Current input	External CT	External CT	External CT
Multi tariff	-	4	8
Communication	Modbus RS485	Ethernet	Ethernet
Active Energy accuracy	Cl 0.5S with 15th harmonic	Cl 0.5S with 31st harmonic	Cl 0.2S with 63rd harmonic
I/O	1DO	2DI/ 2DO	2DI/ 2DO
Reference	METSEPM5110	METSEPM5320	METSEPM5560

3



04. Altivar soft starters and Altivar variable speed drives

Altivar Soft Starter ATS01 is for HVAC, pumps, compressors, and other basic motors



1 Altivar soft starter ATS01 for 0.37 to 11 kW motors and single or 3-phase supply voltage 110...480 V 50/60 Hz (1)

Power for single-phase motor (2)	Under 230 V (kW)	0.37	0.75	1.1	1.5	2.2				
Power for 3-phase motor (2)	Under 110 V (HP)	–	–	0.5	–	1	1.5	2	3	
	Under 230 V (kW)	0.37	0.55	0.75	1.1	1.5	2.2	3	4	5.5
	Under 230 V (HP)	0.5	–	1	1.5	2	3	5	7.5	
	Under 400 V (kW)	1.1	–	2.2	3	4	5.5	7.5	9	11
	Under 460 V (HP)	0.5	1.5	2	3	5	7.5	10	15	
Nominal current I_{cL} (A) (3)		3	6	9	12	25				
Dimensions: W x D x H (mm)		22.5 x 100.4 x 100				45 x 130.7 x 124				
Reference		ATS01N103FT	ATS01N106FT	ATS01N109FT	ATS01N112FT	ATS01N125FT				

2 Altivar soft starter ATS01 units for 0.75 to 15 kW motors (4) and 3-phase supply voltage 220...240 V 50/60 Hz (5)

Power for 3-phase motor 220...240 V 50/60 Hz (kW) (2)	0.75/1.1	1.5	2.2/3	4/5.5	7.5
Power in HP (2)	1/1.5	2	3/-	5/7.5	10
Nominal current I_{cL} (A) (3)	6	9	12	22	32
Dimensions: W x D x H (mm)	45 x 130.7 x 124			45 x 130.7 x 154	
Reference	ATS01N206LU	ATS01N209LU	ATS01N212LU	ATS01N222LU	ATS01N232LU

Altivar soft starter ATS01 units for 0.75 to 15 kW motors (4) and 3-phase supply voltage 380...415 V 50/60 Hz (5)

Power for 3-phase motor 380...415 V 50/60 Hz (kW) (2)	1.5/2.2/3	4	5.5	7.5/11	15
Power in HP (2)	–	–	–	–	–
Nominal current I_{cL} (A) (3)	6	9	12	22	32
Dimensions: W x D x H (mm)	45 x 130.7 x 124			45 x 130.7 x 154	
Reference	ATS01N206QN	ATS01N209QN	ATS01N212QN	ATS01N222QN	ATS01N232QN

Altivar soft starter ATS01 units for 0.75 to 15 kW motors (4) and 3-phase supply voltage 440...480 V 50/60 Hz (5)

Power for 3-phase motor 440...480 V 50/60 Hz (kW) (2)	–	–	–	–	–
Power in HP (2)	2/3	5	7.5	10/15	20
Nominal current I_{cL} (A) (3)	6	9	12	22	32
Dimensions: W x D x H (mm)	45 x 130.7 x 124			45 x 130.7 x 154	
Reference	ATS01N206RT	ATS01N209RT	ATS01N212RT	ATS01N222RT	ATS01N232RT

(1) Number of possible start-stops/hour: 100 for starting time of 1 s maximum, 20 for starting time of 5 s maximum.
 (2) Standard motor power ratings, HP power ratings indicated according to standard UL508. (3) I_{cL} corresponds to the starter rating. (4) Control power supply built into the starter.
 (5) Number of possible start-stops/hour: 100 for starting time of 1 s maximum, 20 for starting time of 5 s maximum, 10 for starting time of 10 s maximum.

Altivar Soft Starter ATS22 is for building and industrial segments



Altivar soft starter ATS22 units for 3-phase power supply voltage 208...600 V and 110 V control power supply Connection in the motor power supply line

Motor power in HP	208 V	3	7.5	–	15	20	25	30	40
	230 V	5	10	15	20	25	30	40	50
	460 V	10	10	30	40	50	60	75	100
	575 V	15	25	40	50	60	75	100	125
Nominal current I_{cL} (A) (6)		17	32	47	62	75	88	110	140
Number of starts/hour	Without fan	6	6	6	6	6	6	4	4
	With fan (7)	10	10	10	10	10	10	10	10
Dimensions: W x H x D (mm)		130 x 265 x 169			145 x 295 x 207			150 x 356 x 229.5	
Reference		ATS22D17S6U	ATS22D32S6U	ATS22D47S6U	ATS22D62S6U	ATS22D75S6U	ATS22D88S6U	ATS22C11S6U	ATS22C14S6U

Motor power in HP	208 V	50	60	75	100	125	150	–
	230 V	60	75	100	125	150	–	200
	460 V	125	150	200	250	300	350	400
	575 V	150	200	250	300	350	400	500
Nominal current I_{cL} (A) (6)		170	210	250	320	410	480	590
Number of starts/hour	Without fan	4	–	–	–	–	–	–
	With fan (7)	10	4	4	4	4	4	4
Dimensions: W x H x D (mm)		150 x 356 x 229.5	206 X 425 X 299		206 X 425 X 299		304 x 455 x 340	
Reference		ATS22C17S6U	ATS22C21S6U	ATS22C25S6U	ATS22C32S6U	ATS22C41S6U	ATS22C48S6U	ATS22C59S6U

Note: All values given for Altivar soft starter ATS22 are defined for 3.5 x I_n and 20 s starting time, with motors with thermal protection class 10. These values are for an ambient temperature of 40 °C.
 (6) I_{cL} corresponds to the starter rating. (7) All soft starters from motor power 75 HP to 200 HP (ATS22C21.. to ATS22C59..) are equipped with a fan as standard.



Altivar Soft Starter ATS22 is for building and industrial segments



1 Altivar soft starter ATS22 units for 3-phase power supply voltage 230...440 V and 220 V 50-60 Hz control power supply Connection in the motor power supply line or in the motor delta connection (1)

Motor power in kW (motor power supply line)	230 V	4	7.5	11	15	18.5	22	30	37	
	400 V	7.5	15	22	30	37	45	55	75	
	440 V	7.5	15	22	30	37	45	55	75	
Motor power in kW (motor delta connection) (1)	230 V	5.5	11	18.5	22	30	37	45	55	
	400 V	11	22	45	55	55	75	90	110	
	440 V	15	22	45	55	75	75	90	110	
Nominal current I _{cL} (A) (2)		17	32	47	62	75	88	110	140	
Number of starts/hour	Without fan	6	6	6	6	6	6	4	4	
	With fan (3)	10	10	10	10	10	10	10	10	
Dimensions: W x H x D (mm)		130 x 265 x 169				145 x 295 x 207			150 x 356 x 229.5	
Reference		ATS22D17Q	ATS22D32Q	ATS22D47Q	ATS22D62Q	ATS22D75Q	ATS22D88Q	ATS22C11Q	ATS22C14Q	

Motor power in kW (motor power supply line)	230 V	45	55	75	90	110	132	160
	400 V	90	110	132	160	220	250	315
	440 V	90	110	132	160	220	250	355
Motor power in kW (motor delta connection) (1)	230 V	75	90	110	132	160	220	250
	400 V	132	160	220	250	315	355	400
	440 V	132	160	220	250	355	400	500
Nominal current I _{cL} (A) (2)		170	210	250	320	410	480	590
Number of starts/hour	Without fan	4	–	–	–	–	–	–
	With fan (3)	10	4	4	4	4	4	4
Dimensions: W x H x D (mm)		150 x 356 x 229.5	206 X 425 X 299			304 x 455 x 340		
Reference		ATS22C17Q	ATS22C21Q	ATS22C25Q	ATS22C32Q	ATS22C41Q	ATS22C48Q	ATS22C59Q

2 Altivar soft starter ATS22 units for 3-phase power supply voltage 230...500 V and 220 V 50-60 Hz control power supply Connection in the motor power supply line

Motor power in kW	230 V	4	7.5	11	15	18.5	22	30	37	
	400 V	7.5	15	22	30	37	45	55	75	
	440 V	7.5	15	22	30	37	45	55	75	
	500 V	9	18.5	30	37	45	55	75	90	
Nominal current I _{cL} (A) (2)		17	32	47	62	75	88	110	140	
Number of starts/hour	Without fan	–	–	–	–	–	–	–	–	
	With fan (3)	4	4	4	4	4	4	4	4	
Dimensions: W x H x D (mm)		130 x 265 x 169				145 x 295 x 207			150 x 356 x 229.5	
References		ATS22D17S6	ATS22D32S6	ATS22D47S6	ATS22D62S6	ATS22D75S6	ATS22D88S6	ATS22C11S6	ATS22C14S6	

Motor power in kW	230 V	45	55	75	90	110	132	160	
	400 V	90	110	132	160	220	250	315	
	440 V	90	110	132	160	220	250	355	
	500 V	110	132	160	220	250	315	400	
Nominal current I _{cL} (A) (2)		170	210	250	320	410	480	590	
Number of starts/hour	Without fan	4	–	–	–	–	–	–	
	With fan (3)	10	4	4	4	4	4	4	
Dimensions: W x H x D (mm)		150 x 356 x 229.5	206 X 425 X 299			206 X 425 X 299		304 x 455 x 340	
Reference		ATS22C17S6	ATS22C21S6	ATS22C25S6	ATS22C32S6	ATS22C41S6	ATS22C48S6	ATS22C59S6	

Note: All values given for Altivar soft starter ATS22 are defined for 3.5 x I_n and 20 s starting time, with motors with thermal protection class 10. These values are for an ambient temperature of 40 °C.

(1) When connected in the delta configuration, starters allow the use of motors of a larger rating relative to that of the starter. In this configuration, the nominal motor current should not exceed 1.5 I_{cL}.

(2) I_{cL} corresponds to the starter rating.

(3) All soft starters from motor power 55 kW to 160 kW (ATS22C21.. to ATS22C59..) are equipped with a fan as standard.

For soft starters under 55 kW (ATS22D17.. to ATS22C17..), the number of starts per hour can be increased by adding a fan. For more details, please refer to the product datasheets on our website www.schneider-electric.com

Altivar 212 - IP21 drives for building and HVAC projects (fan, pump, compressor)



Three-phase supply voltage: 200...240 V 50/60 Hz, without EMC filter (1)

Motor	Power indicated on rating plate in kW	0.75	1.5	2.2	3	4	5.5
	Power indicated on rating plate in HP	1	2	3	–	5	7.5
Altivar 212	Max. continuous output current (In) 230 V in A (2)	4.6	7.5	10.6	13.7	18.7	24.2
Dimensions: W x H x D (mm)	EMC plate mounted (mm)	107 x 192 x 150			142 x 232 x 150		180 x 307 x 170
	EMC plate not mounted (mm)	107 x 143 x 150			142 x 184 x 150		180 x 232 x 170
Reference		ATV212H075M3X	ATV212HU15M3X	ATV212HU22M3X	ATV212HU30M3X	ATV212HU40M3X	ATV212HU55M3X

Motor	Power indicated on rating plate in kW	7.5	11	15	18.5	22	30
	Power indicated on rating plate in HP	10	15	20	25	30	40
Altivar 212	Max. continuous output current (In) 230 V in A (2)	32	46.2	61	74.8	88	117
Dimensions: W x H x D (mm)	EMC plate mounted (mm)	180 x 307 x 170	245 x 405 x 190			240 x 542 x 214	320 x 723 x 290
	EMC plate not mounted (mm)	180 x 232 x 170	246 x 330 x 190			240 x 420 x 214	320 x 605 x 290
Reference		ATV212HU75M3X	ATV212HD11M3X	ATV212HD15M3X	ATV212HD18M3X	ATV212HD22M3X	ATV212HD30M3X

Three-phase supply voltage: 380...480 V 50/60 Hz, with integrated category C2 or C3 EMC filter (1)

Motor	Power indicated on rating plate in kW	0.75	1.5	2.2	3	4	5.5
	Power indicated on rating plate in HP	1	2	3	3	5	7.5
Altivar 212	Max. continuous output current (In) in A (2)	2.2	3.7	5.1	7.2	9.1	12
Dimensions: W x H x D (mm)	EMC plate mounted (mm)	107 x 192 x 150			142 x 232 x 150		
	EMC plate not mounted (mm)	107 x 143 x 150			142 x 184 x 150		
Reference		ATV212H075N4	ATV212HU15N4	ATV212HU22N4	ATV212HU30N4	ATV212HU40N4	ATV212HU55N4

Motor	Power indicated on rating plate in kW	7.5	11	15	18.5	22	22
	Power indicated on rating plate in HP	10	15	20	25	30	30
Altivar 212	Max. continuous output current (In) in A (2)	16	22.5	30.5	37	43.5	43.5
Dimensions: W x H x D (mm)	EMC plate mounted (mm)	180 x 307 x 170	245 x 405 x 190			240 x 542 x 214	
	EMC plate not mounted (mm)	180 x 232 x 170	245 x 330 x 190			240 x 420 x 214	
Reference		ATV212HU75N4	ATV212HD11N4	ATV212HD15N4	ATV212HD18N4	ATV212HD22N4S	ATV212HD22N4

Motor	Power indicated on rating plate in kW	30	37	45	55	75
	Power indicated on rating plate in HP	40	50	60	75	100
Altivar 212	Max. continuous output current (In) in A (2)	58.5	79	94	116	160
Dimensions: W x H x D (mm)	EMC plate mounted (mm)	240 x 542 x 214	240 x 663 x 244		320 x 723 x 290	
	EMC plate not mounted (mm)	240 x 420 x 214	240 x 550 x 244		320 x 605 x 290	
Reference		ATV212HD30N4	ATV212HD37N4	ATV212HD45N4	ATV212HD55N4	ATV212HD75N4

(1) Drives are supplied with an EMC plate, for customer assembly.
 (2) These values are given for a nominal switching frequency of 12 kHz up to ATV212HD15M3X and up to ATV212HD15N4 or 8 kHz for ATV21HD18M3X... HD30M3X and ATV212HD18N4...HD75N4, for use in continuous operation. The switching frequency can be set between 6 and 16 kHz for all ratings. Above 8 kHz or 12 kHz, depending on the rating, the drive will reduce the switching frequency automatically in the event of an excessive temperature rise. For continuous operation above the nominal switching frequency, derate the nominal drive current. The nominal motor current must not exceed this derating value. See the derating curves on our website www.schneider-electric.com.

Setup ATV212 with "Ecostruxure Industrial Device" Mobile Application

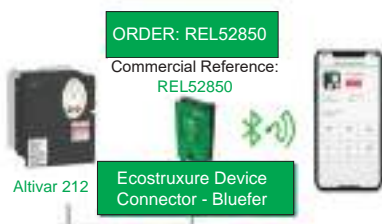

Free

"Ecostruxure Industrial Device" mobile application for IOS or Android

Download the application via application stores:



Modbus RS232 Serial Cable with RJ45 Connectors on both sides

Ecostruxure Device Connector - Bluefer is necessary to connect mobile application to ATV212

Altivar 12 ultra-compact variable speed drives for commercial equipment



1 Altivar 12 drives with heatsink and single-phase supply voltage: 100...120 V 50/60 Hz (1) (2)

Motor	Power indicated on plate in kW (3)	0.18	0.37	0.75
	Power indicated on plate in HP (3)	0.25	0.5	1
Altivar 12	Max. continuous output current (3)	1.4	2.4	4.2
	Embedded communication	Modbus Serial Line		
	Application intelligence	Embedded functions		
	Withstand to harsh environment	Up to 60 °C with derating		
Dimensions: W x H x D (mm) (4)		72 x 143 x 102	72 x 143 x 121	105 x 142 x 156
Reference		ATV12 H018F1 (4)	ATV12 H037F1	ATV12 H075F1

Altivar 12 drives with heatsink and single-phase supply voltage: 200...240 V 50/60 Hz (1) (2)

Motor	Power indicated on plate in kW (3)	0.18	0.37	0.55	0.75	1.5	2.2
	Power indicated on plate in HP (3)	0.25	0.55	0.75	1	2	3
Altivar 12	Max. continuous output current (3)	1.4	2.4	3.5	4.2	7.5	10
	Dimensions: W x H x D (mm) (4)	72 x 143 x 102	72 x 143 x 121	72 x 143 x 131		105 x 142 x 156	
Reference		ATV12 H018M2 (4)	ATV12 H037M2	ATV12 H055M2	ATV12 H075M2	ATV12 HU15M2	ATV12 HU22M2

Altivar 12 drives with heatsink and three-phase supply voltage: 200...240 V 50/60 Hz (1) (2)

Motor	Power indicated on plate in kW (3)	0.18	0.37	0.75	1.5	2.2	3	4
	Power indicated on plate in HP (3)	0.25	0.55	1	2	3	–	5
Altivar 12	Max. continuous output current (3)	1.4	2.4	4.2	7.5	10	12.2	16.7
	Dimensions: W x H x D (mm) (4)	72 x 143 x 102	72 x 143 x 121	72 x 143 x 131	105 x 143 x 131		140 x 184 x 141	
Reference		ATV12 H018M3 (4)	ATV12 H037M3	ATV12 H075M3	ATV12 HU15M3	ATV12 HU22M3	ATV12 HU30M3	ATV12 HU40M3

2 Accessories for Altivar 12 drives

Accessory	Simple Loader configuration tool (5)	Multi-Loader configuration tool (5)	USB/RJ45 cable for PC-drive connection
Compatibility	All Altivar 12 variable speed drives		
Reference	VW3A8120	VW3A8121	TCSMCNAM3M002P

Note: Altivar 12 variable speed drives are designed for 3-phase asynchronous motors.
 (1) Min. (U1) and max. (U2) nominal supply voltage: 100 (U1)...120 V (U2), 200 (U1)...240 V (U2).
 (2) Altivar 12 variable speed drives are supplied with built-in EMC filters and comply with standard IEC/EN 61800-3. For more information, please refer to the product datasheet on our website www.schneider-electric.com.
 (3) These values are given for a nominal switching frequency of 4 kHz, for continuous operation. For derated operation, please refer to the product catalog. ATV12 variable speed drives can supply a transient output current of 1.5 x In for 60 s for every 10 min. cycle.
 (4) All dimensions provided are without EMC plate installed.
 (5) For more information about this tool, please refer to the product datasheet on our website www.schneider-electric.com.

Communication modules and accessories for ATV320 variable speed drives



3 Communication buses and networks for ATV320

Type of communication module (6)	CANopen daisy chain (7) (8) (9)	CANopen SUB-D9 (7) (8) (9)	CANopen open style (7) (8) (9)
Reference	VW3A3608	VW3A3618	VW3A3628
Type of communication module (6)	Modbus TCP and Ethernet/IP network module (8)	PROFIBUS DP V1 communication module (8)	DeviceNet communication module (8)
Reference	VW3A3616	VW3A3607	VW3A3609
Type of communication module (6)	EtherCat communication module (8)	ProfiNet communication module (8)	Powerlink Communication module
Reference	VW3A3601	VW3A3627	VW3A3619

4 Accessories

Type of accessory	Communication adapter module (6)	Advance keypad	
Compatibility	ATV320 compact	All Altivar Machine ATV320 variable speed drives	
Reference (8)	VW3A3600	VW3A1111	
Type of accessory	Simple Loader configuration tool (10)	Multi-Loader configuration tool (10)	USB/RJ45 cable for PC-drive connection
Compatibility	All Altivar Machine ATV320 variable speed drives		
Reference	VW3A8120	VW3A8121	TCSMCNAM3M002P

(6) Altivar Machine ATV320 products with a compact control block require the VW3A3600 option adapter module in order to use any optional communication module.
 (7) The Modbus serial link always uses the RJ45 communication port. If simultaneous use of the Modbus serial link and the CANopen machine bus is required, a CANopen communication module is needed.
 (8) The Altivar Machine ATV320 drive can only take one communication module.
 (9) When one of the CANopen communication modules is inserted in the Altivar Machine ATV320 drive, CANopen communication via the RJ45 communication port is disabled.
 (10) For more information about this tool, please refer to the product datasheet on our website www.schneider-electric.com.

Altivar Machine ATV320 variable speed drives for simple and advanced machines



1 ATV320 drives with compact control block and single-phase supply voltage 200...240 V 50/60 Hz

Motor	Power indicated on plate in kW	0.18	0.37	0.55	0.75	1.1	1.5	2.2
	Power indicated on plate in HP	0.25	0.5	0.75	1	1.5	2	3
Altivar 320	Max. continuous output current (1)	1.5	3.3	3.7	4.8	6.9	8	11
Dimensions: W x H x D (mm)		72 x 143 x 109		72 x 143 x 128		72 x 143 x 138		105 x 142 x 158
Reference		ATV320 U02M2C	ATV320 U04M2C	ATV320 U06M2C	ATV320 U07M2C	ATV320 U11M2C	ATV320 U15M2C	ATV320 U22M2C

ATV320 drives with compact control block and three-phase supply voltage 380...500 V 50/60 Hz

Motor	Power indicated on plate in kW	0.37	0.55	0.75	1.1	1.5	2.2	3	4
	Power indicated on plate in HP	0.5	0.75	1	1.5	2	3	4	5
Altivar 320	Max. continuous output current (1)	1.5	1.9	2.3	3	4.1	5.5	7.1	9.5
Dimensions: W x H x D (mm)		105 x 143 x 158				140 x 184 x 158			
Reference		ATV320 U04N4C	ATV320 U06N4C	ATV320 U07N4C	ATV320 U11N4C	ATV320 U15N4C	ATV320 U22N4C	ATV320 U30N4C	ATV320 U40N4C

Motor	Power indicated on plate in kW	5.5	7.5	11	15
	Power indicated on plate in HP	7.5	10	15	20
Altivar 320	Max. continuous output current (1)	14.3	17	27.7	33
Dimensions: W x H x D (mm)		150 x 232 x 178		180 x 330 x 198	
Reference		ATV320 U55N4C	ATV320 U75N4C	ATV320 D11N4C	ATV320 D15N4C

ATV320 drives with book control block and single-phase supply voltage 200...240 V 50/60 Hz

Motor	Power indicated on plate in kW	0.18	0.37	0.55	0.75	1.1	1.5	2.2
	Power indicated on plate in HP	0.25	0.5	0.75	1	1.5	2	3
Altivar 320	Max. continuous output current (1)	1.5	3.3	3.7	4.8	6.9	8	11
Dimensions: W x H x D (mm)		45 x 325 x 245				60 x 325 x 245		
Reference		ATV320 U02M2B	ATV320 U04M2B	ATV320 U06M2B	ATV320 U07M2B	ATV320 U11M2B	ATV320 U15M2B	ATV320 U22M2B

ATV320 drives with book control block and three-phase supply voltage 380...500 V 50/60 Hz

Motor	Power indicated on plate in kW	0.37	0.55	0.75	1.1	1.5	2.2	3	4
	Power indicated on plate in HP	0.5	0.75	1	1.5	2	3	4	5
Altivar 320	Max. continuous output current (1)	1.5	1.9	2.3	3	4.1	5.5	7.1	9.5
Dimensions: W x H x D (mm)		45 x 325 x 245				60 x 325 x 245			
Reference		ATV320 U04N4B	ATV320 U06N4B	ATV320 U07N4B	ATV320 U11N4B	ATV320 U15N4B	ATV320 U22N4B	ATV320 U30N4B	ATV320 U40N4B

Motor	Power indicated on plate in kW	5.5	7.5	11	15
	Power indicated on plate in HP	7.5	10	15	20
Altivar 320	Max. continuous output current (1)	14.3	17	27.7	33
Dimensions: W x H x D (mm)		150 x 232 x 232		180 x 330 x 232	
Reference		ATV320 U55N4B	ATV320 U75N4B	ATV320 D11N4B	ATV320 D15N4B

2 Altivar with high IP enclosure and single-phase supply voltage: 200...240 V 50/60Hz

Motor	Power indicated on plate in kW	0.18	0.37	0.55	0.75	1.1	1.5	2.2
	Power indicated on plate in HP	0.25	0.5	0.75	1	1.5	2	3
Altivar 320	Max. continuous output current (1)	1.5	3.3	3.7	4.8	6.9	8	11
Dimensions: W x H x D (mm) (2)		250 x 340 x 182				250 x 340 x 235		
Reference		ATV320 U02M2W(S)	ATV320 U04M2W(S)	ATV320 U06M2W(S)	ATV320 U07M2W(S)	ATV320 U11M2W(S)	ATV320 U15M2W(S)	ATV320 U22M2W(S)

Altivar with high IP enclosure and three-phase supply voltage 380...500 V 50/60 Hz

Motor	Power indicated on plate in kW	0.37	0.55	0.75	1.1	1.5	2.2	3	4
	Power indicated on plate in HP	0.5	0.75	1	1.5	2	3	4	5
Altivar 320	Max. continuous output current (1)	1.5	1.9	2.3	3	4.1	5.5	7.1	9.5
Dimensions: W x H x D (mm) (2)		250 x 340 x 200				250 x 340 x 235			
Reference		ATV320 U04N4W(S)	ATV320 U06N4W(S)	ATV320 U07N4W(S)	ATV320 U11N4W(S)	ATV320 U15N4W(S)	ATV320 U15M2W(S)	ATV320 U30N4W(S)	ATV320 U40N4W(S)

Motor	Power indicated on plate in kW	5.5	7.5
	Power indicated on plate in HP	7.5	10
Altivar 320	Max. continuous output current (1)	14.3	17
Dimensions: W x H x D (mm) (2)		320 x 521 x 335	
Reference		ATV320 U55N4W(S)	ATV320 U75N4W(S)

Note: Altivar Machine ATV320 variable speed drives are designed for 3-phase synchronous and asynchronous motors. ATV320 drives are supplied with braking chopper as standard. For braking resistor selection, please refer to the product catalog on our website www.schneider-electric.com.

(1) Altivar Machine ATV320 variable speed drives can supply a transient output current of 1.5 x In for 60 s.

(2) To obtain the new references for ATV320 IP66 drives, replace the last character with "W" (without switch) or "WS" (with switch)





05. Harmony interface, measurement and control relays

Zelio Logic smart relays



Compact smart relays and compact "discovery" packs

AC supply voltage		24 VAC		48 VAC	100...240 VAC			
Number of inputs/outputs		12	20	20	10	12	20	
Number of discrete inputs		8	12	12	6	8	12	
Number of outputs		4 relay	8 relay	8 relay	4 relay	4 relay	8 relay	
Clock		Yes	Yes	No	No	Yes	No	
Compact smart relays	With display	SR2B121B	SR2B201B	SR2A201E	SR2A101FU (1)	SR2B121FU	SR2A201FU (1)	SR2B201FU
	Without display (1)	SR2E121B	SR2E201B	–	SR2D101FU (1)	SR2E121FU	SR2D201FU (1)	SR2E201FU
Compact discovery packs (2)		–	–	–	–	SR2PACKFU	–	SR2PACK2FU

DC supply voltage		12 VDC			24 VDC		
Number of inputs/outputs		12	20	10	12	20	20
Number of discrete inputs		8	12	6	8	12	12
including 0-10 V analog inputs		4	6	–	4	2	6
Number of outputs		4 relay	8 relay	4 relay	4	8 relay	8
Clock		Yes	Yes	No	Yes	No	Yes
Compact smart relays	With display	SR2B121JD	SR2B201JD	SR2A101BD (1)	SR2B12●BD (3)	SR2A201BD (1)	SR2B20●BD (3)
	Without display	–	–	SR2D101BD (1)	SR2E121BD	SR2D201BD (1)	SR2E201BD
Compact discovery packs (2)		–	–	–	SR2PACKBD	–	SR2PACK2BD

Modular smart relays (4) with display and modular "discovery" packs

Supply voltage		24 VAC		100...240 VAC		12 VDC	24 VDC
Number of inputs/outputs		10	26	10	26	10	26
Number of discrete inputs		6	16	6	16	6	16
including 0-10 V analog inputs		–	–	–	–	6	6
Number of outputs		4 relay	10 relay	4 relay	10 relay	10 relay	4
Clock		Yes	Yes	Yes	Yes	Yes	Yes
Modular smart relays (2)		SR3B101B	SR3B261B	SR3B101FU	SR3B261FU	SR3B261JD	SR3B10●BD (5)
Modular discovery packs (2)		–	–	SR3PACKFU	SR3PACK2FU	–	SR3PACKBD
							SR3B26●BD (5)
							SR3PACK2BD



Extension modules for Zelio Logic SR3B●●●●●● (6)

Type of module		Communication modules (4)		Discrete I/O modules (5)			Analog I/O modules
Network type		Modbus	Ethernet	–			–
Number of inputs/outputs		–	–	6	10	14	4
Number of discrete inputs		–	–	4	6	8	2 (0...10 V, 0...20 mA, PT100)
Number of outputs		–	–	2 relay	4 relay	6 relay	2 (0...10 V)
References	24 VAC	–	–	SR3XT61B	SR3XT101B	SR3XT141B	–
	100...240 VAC	–	–	SR3XT61FU	SR3XT101FU	SR3XT141FU	–
	12 VDC	–	–	SR3XT61JD	SR3XT101JD	SR3XT141JD	–
	24 VDC	SR3MBU01BD	SR3NET01BD	SR3XT61BD	SR3XT101BD	SR3XT141BD	SR3XT43BD

Zelio Soft 2 software and accessories

Type of device		Zelio Soft multilingual programming software (6)	Connecting cables		Wireless connection	Back-up memory
Description		PC CD-ROM (7)	Serial PC/Smart relay	USB PC/Smart relay	Bluetooth interface	EEPROM
References		SR2SFT01	SR2CBL01	SR2USB01	SR2BTC01	SR2MEM02

(1) Programming on smart relay in LADDER language only.

(2) The packs are composed of one smart relay with display and relay output, one SR2SFT01 Zelio soft 2 software, and one SR2USB01 connecting cable.

(3) Replace the ● with the number 1 to order a smart relay with relay output or the number 2 for a smart relay with transistor output (e.g. SR2B121BD).

(4) The modular base can be equipped with one I/O extension module. The 24 VDC modular base can be equipped with one communication module and/or one I/O extension module.

(5) Replace the ● with the number 1 to order a smart relay with relay output or the number 2 for a smart relay with transistor output (e.g. SR3B101BD).

(6) The power supply for the extension modules is provided via the Zelio Logic modular relays.

(7) CD-ROM (Windows 7 - 32 and 64 bits, Windows 8.1 - 32 and 64 bits, Windows 10) including Zelio Soft programming software, an application library, a self-training manual, installation instructions, and a user manual.

Harmony Relay RXG and RSB electromechanical relays



RXG interface relays

Type	RXG relays without test button				RXG relays with test button				
Contact	1 CO		2 CO		1 CO		2 CO		
Current	10 A		5 A		10 A		5 A		
Connection	Flat pins (Faston type)				Flat pins (Faston type)				
LED display	Without LED	With LED	Without LED	With LED	Without LED	With LED	Without LED	With LED	
Complete product	6 VDC	–	–	–	–	RXG12RD	RXG21RD	–	
	12 VDC	RXG15JD	RXG13JD	–	–	RXG11JD	RXG12JD	RXG21JD	RXG22JD
	24 VDC	RXG15BD	RXG13BD	RXG25BD	RXG23BD	RXG11BD	RXG12BD	RXG21BD	RXG22BD
	48 VDC	–	–	–	–	–	RXG12ED	–	RXG22ED
	110 VDC	–	–	–	–	–	RXG12FD	–	RXG22FD
	24 VAC	–	RXG13B7	RXG25B7	RXG23B7	RXG11B7	RXG12B7	RXG21B7	RXG22B7
	48 VAC	–	–	–	RXG23E7	–	RXG12E7	RXG21E7	RXG22E7
	120 VAC	RXG15F7	RXG13F7	RXG25F7	RXG23F7	RXG11F7	RXG12F7	RXG21F7	RXG22F7
	220 VAC	–	–	RXG25M7	RXG23M7	–	–	RXG21M7	RXG22M7
230 VAC	RXG15P7	RXG13P7	RXG25P7	RXG23P7	RXG11P7	RXG12P7	RXG21P7	RXG22P7	
Screw connector socket	RGZE1S35M		RGZE1S48M		RGZE1S35M		RGZE1S48M		
Push-in socket	RGZE05P		RGZE08P		RGZE05P		RGZE08P		
Pre-mounted product	24 VDC	–	RXG13BDPV	–	RXG23BDPV	–	RXG12BDPV	RXG21BDPV	RXG22BDPV
	24 VAC	–	–	–	–	–	RXG12B7PV	RXG21B7PV	RXG22B7PV
	230 VAC	–	RXG13P7PV	–	RXG23P7PV	–	RXG12P7PV	RXG21P7PV	RXG22P7PV

Note: RXG pre-mounted version includes relay + socket + protection module (diode for DC coil/varistor for AC coil) + clamp, sold in lots of 30 units.

5



RSB interface relay

Contact	1 CO		1 CO		2 CO		
Current	12 A		16 A		8 A		
Connection	PCB Type						
Complete product	6 VDC	–	RSB1A160RD		–		
	12 VDC	RSB1A120JD	RSB1A160JD		RSB2A080JD		
	24 VDC	RSB1A120BD	RSB1A160BD		RSB2A080BD		
	48 VDC	RSB1A120ED	RSB1A160ED		RSB2A080ED		
	60 VDC	–	RSB1A160ND		–		
	110 VDC	RSB1A120FD	RSB1A160FD		RSB2A080FD		
	24 VAC	RSB1A120B7	RSB1A160B7		RSB2A080B7		
	48 VAC	RSB1A120E7	RSB1A160E7		RSB2A080E7		
	120 VAC	RSB1A120F7	RSB1A160F7		RSB2A080F7		
	220 VAC	RSB1A120M7	RSB1A160M7		RSB2A080M7		
	230 VAC	RSB1A120P7	RSB1A160P7		RSB2A080P7		
	240 VAC	RSB1A120U7	RSB1A160U7		RSB2A080U7		
	Screw connector socket	RSZE1S35M		RSZE1S48M		RSZE1S48M	
	Push-in socket	RSZE05P		RSZE08P		RSZE08P	
Pre-mounted product	12 VDC	RSB1A120JDPV	–		RSB2A080JDPV		
	24 VDC	RSB1A120BDPV	RSB1A160BDPV		RSB2A080BDPV		
	24 VAC	RSB1A120B7PV	–		RSB2A080B7PV		
	120 VAC	RSB1A120F7PV	–		RSB2A080F7PV		
	220 VAC	–	–		RSB2A080M7PV		
230 VAC	RSB1A120P7PV	RSB1A160P7PV		RSB2A080P7PV			

Note: RSB pre-mounted version includes relay + socket + protection module + clamp + label, sold in lots of 30 units.

Harmony Relay RSL, RXM, and RPM electromechanical relays



RSL interface relays							
Type	RSL relays			Sockets for RSL relays		Pre-assembled relays/sockets	
Contact	1 CO			-		1 CO	
Current	6 A - standard	6 A - low level		-		6 A	
Connection	PCB pins			Screw connector	Spring terminal		Screw connector Spring terminal
LED display	Without LED			-		With LED	
Complete product	12 VAC/VDC	RSL1AB4JD	RSL1GB4JD	RSLZVA1	RSLZRA1	RSL1PVJU	RSL1PRJU
	24 VAC/VDC	RSL1AB4BD	RSL1GB4BD	RSLZVA1	RSLZRA1	RSL1PVBU	RSL1PRBU
	48 VAC/VDC	RSL1AB4ED	RSL1GB4ED	RSLZVA2	RSLZRA2	RSL1PVEU	RSL1PREU
	60 VAC/VDC	RSL1AB4ND	RSL1GB4ND	RSLZVA2	RSLZRA2	-	-
	110 VAC/VDC	-	-	RSLZVA3	RSLZRA3	RSL1PVFU	RSL1PRFU
	230 VAC/VDC	-	-	RSLZVA4	RSLZRA4	RSL1PVPU	RSL1PRPU

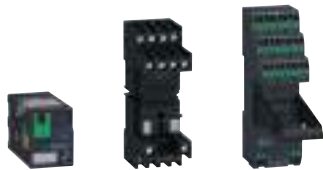

RXM●AB miniature relays								
Type	RXM●AB relays with test button							
Contact	2 CO		3 CO		4 CO			
Current	12 A		10 A		6 A			
Connection	Flat pins (Faston type)							
LED display	Without LED		With LED		Without LED		With LED	
Complete product	12 VDC	RXM2AB1JD	RXM2AB2JD	RXM3AB1JD	RXM3AB2JD	RXM4AB1JD	RXM4AB2JD	
	24 VDC	RXM2AB1BD	RXM2AB2BD	RXM3AB1BD	RXM3AB2BD	RXM4AB1BD	RXM4AB2BD	
	48 VDC	RXM2AB1ED	RXM2AB2ED	RXM3AB1ED	-	RXM4AB1ED	RXM4AB2ED	
	110 VDC	RXM2AB1FD	RXM2AB2FD	RXM3AB1FD	RXM3AB2FD	RXM4AB1FD	RXM4AB2FD	
	24 VAC	RXM2AB1B7	RXM2AB2B7	RXM3AB1B7	RXM3AB2B7	RXM4AB1B7	RXM4AB2B7	
	48 VAC	RXM2AB1E7	RXM2AB2E7	RXM3AB1E7	RXM3AB2E7	RXM4AB1E7	RXM4AB2E7	
	120 VAC	RXM2AB1F7	RXM2AB2F7	RXM3AB1F7	RXM3AB2F7	RXM4AB1F7	RXM4AB2F7	
	230 VAC	RXM2AB1P7	RXM2AB2P7	RXM3AB1P7	RXM3AB2P7	RXM4AB1P7	RXM4AB2P7	
	220 VDC	-	-	-	-	RXM4AB1MD	-	
	240 VDC	-	-	-	-	RXM4AB1U7	-	
	Screw clamp socket (1)	RXZE2M114		-		RXZE2M114		
	Screw connector socket (1)	RXZE2M114M		-		RXZE2M114M		
	Screw connector socket (2)	RXZE2S108M		RXZE2S111M		RXZE2S114M		
Push-in socket	RXZE14P		-		RXZE14P			
Pre-mounted product	24 VDC	-	RXM2AB2BDPVM (3)	-		RXM4AB1BDPVM (3)	RXM4AB2BDPVM (3)	
	24 VAC	-	RXM2AB2B7PVM (3)	-		RXM4AB1B7PVM (3)	RXM4AB2B7PVM (3)	
	230 VAC	-	RXM2AB2P7PVM (3)	-		RXM4AB1P7PVM (3)	RXM4AB2P7PVM (3)	
	24 VDC	-	RXM2AB2BDPVS (4)	-		RXM4AB1BDPVS (4)	RXM4AB2BDPVS (4)	
	24 VAC	-	RXM2AB2B7PVS (4)	-		RXM4AB1B7PVS (4)	RXM4AB2B7PVS (4)	
	230 VAC	-	RXM2AB2P7PVS (4)	-		RXM4AB1P7PVS (4)	RXM4AB2P7PVS (4)	



RPM power relays (15 A)									
Type	RPM relays with test button								
Contact	1 CO			2 CO		3 CO		4 CO	
Current	15 A								
Connection	Flat pins (Faston type)								
LED display	Without LED		With LED		Without LED		With LED		Without LED
Complete product	12 VDC	RPM11JD	RPM12JD	RPM21JD	RPM22JD	RPM31JD	RPM32JD	RPM41JD	RPM42JD
	24 VDC	RPM11BD	RPM12BD	RPM21BD	RPM22BD	RPM31BD	RPM32BD	RPM41BD	RPM42BD
	48 VDC	RPM11ED	RPM12ED	RPM21ED	RPM22ED	RPM31ED	RPM32ED	RPM41ED	RPM42ED
	110 VDC	RPM11FD	-	RPM21FD	RPM22FD	RPM31FD	-	RPM41FD	RPM42FD
	24 VAC	RPM11B7	RPM12B7	RPM21B7	RPM22B7	RPM31B7	RPM32B7	RPM41B7	RPM42B7
	48 VAC	RPM11E7	RPM12E7	RPM21E7	RPM22E7	RPM31E7	RPM32E7	RPM41E7	RPM42E7
	120 VAC	RPM11F7	RPM12F7	RPM21F7	RPM22F7	RPM31F7	RPM32F7	RPM41F7	RPM42F7
	230 VAC	RPM11P7	RPM12P7	RPM21P7	RPM22P7	RPM31P7	RPM32P7	RPM41P7	RPM42P7
Screw connector socket	RPZF1			RPZF2		RPZF3		RPZF4	

(1) With mixed contacts
 (2) With separate contacts
 (3) RXM pre-mounted version includes relay + socket (mixed) + clamp + label, sold in lots of 30 units.
 (4) RXM pre-mounted version includes relay + socket (seperate) + clamp + label, sold in lots of 30 units.

Harmony Control SSL and SSP solid state relays



SSL1 slim interface solid state relays (DC switching)

Type	SSL1 relays (6 mm)		Screw connector socket	Spring terminal socket
Contact	1 NO		–	–
Load current	0.1 A	3.5 A	–	–
Load voltage	1...48 VDC		1...24 VDC	–
Complete product	3...12 VDC	SSL1D101JD	SSL1D03JD	SSLZVA1
	15...30 VDC	SSL1D101BD	SSL1D03BD	SSLZVA1
Pre-mounted product	4...12 VDC	SSL1D101JDPV (1)	SSL1D03JDPV (1)	–
	16...30 VDC	SSL1D101BDPV (1)	SSL1D03BDPV (1)	–
	4...12 VDC	SSL1D101JDPR (2)	SSL1D03JDPR (2)	–
	16...30 VDC	SSL1D101BDPR (2)	SSL1D03BDPR (2)	–

SSL1 slim interface solid state relays (random switching)

Type	SSL1 relays (6 mm)		Screw connector socket	Spring terminal socket
Contact	1 NO		–	–
Load current	2 A		–	–
Load voltage	24...280 VAC		–	–
Complete product	3...12 VDC	SSL1A12JDR	SSLZVA1	SSLZRA1
	15...30 VDC	SSL1A12BDR	SSLZVA1	SSLZRA1
Load voltage	24...250 VAC		–	–
Pre-mounted product	4...12 VDC	SSL1A12JDRPV (1)	–	–
	16...30 VDC	SSL1A12BDRPV (1)	–	–
	4...12 VDC	SSL1A12JDRPR (2)	–	–
	16...30 VDC	SSL1A12BDRPR (2)	–	–

SSL1 slim interface solid state relays (zero voltage switching)

Type	SSL1 relays (6 mm)		Screw connector socket	Spring terminal socket
Contact	1 NO		–	–
Load current	2 A		–	–
Load voltage	24...280 VAC		–	–
Complete product	3...12 VDC	SSL1A12JD	SSLZVA1	SSLZRA1
	15...30 VDC	SSL1A12BD	SSLZVA1	SSLZRA1
Load voltage	24...250 VAC		–	–
Pre-mounted product	4...12 VDC	SSL1A12JDPV (1)	–	–
	16...30 VDC	SSL1A12BDPV (1)	–	–
	4...12 VDC	SSL1A12JDPR (2)	–	–
	16...30 VDC	SSL1A12BDPR (2)	–	–

5



1 SSP1 1-phase panel mount solid state relays (DC switching)

Contact	1 NO		
Load current (3)	12 A	25 A	40 A
Load voltage	1...150 VDC		
Complete product (4)	3.5...32 VDC	SSP1D412BD●	SSP1D425BD●
			SSP1D440BD●

2 SSP1 1-phase panel mount solid state relays (zero voltage switching)

Contact	1 NO							
Load current (3)	10 A	25 A	50 A	50 A	75 A	90 A	125 A	
Load voltage	24...300 VAC	24...300 VAC	24...300 VAC	48...660 VAC	24...300 VAC	48...660 VAC	48...660 VAC	48...660 VAC
Complete product (4)	4...32 VDC	SSP1A110BD●	SSP1A125BD●	SSP1A150BD●	SSP1A450BD●	SSP1A175BD●	SSP1A475BD●	SSP1A490BD●
			(5)	(5)	(5)	(5)	(5)	(5)
	90...280 VAC	SSP1A110M7T	SSP1A125M7●	SSP1A150M7●	SSP1A450M7●	SSP1A175M7T	SSP1A475M7●	SSP1A490M7●
								SSP1A4125BD●
								SSP1A4125M7●

3 SSP3 3-phase panel mount solid state relays (random and zero voltage switching)

Contact	3 NO			
Load current (3)	25 A		50 A	
Load voltage	48...530 VAC			
Switching	Random		Zero voltage	
Complete product (4)	4...32 VDC	SSP3A225BDR●	SSP3A250BDR●	SSP3A225BD●
	18...36 VAC	SSP3A225B7R	SSP3A250B7R●	SSP3A250B7●
	90...140 VAC	–	SSP3A250F7R●	SSP3A225F7●
	180...280 VAC	SSP3A225P7R	SSP3A250P7R●	SSP3A225P7●
				SSP3A250BD●
				SSP3A250B7●
				SSP3A250F7●
				SSP3A250P7●

(1) SSL pre-mounted version includes relay + socket (screw), sold in lots of 30 units.
 (2) SSL pre-mounted version includes relay + socket (spring), sold in lots of 30 units.
 (3) Please use correct heatsink for desired load current: see performance curves in product datasheets available on our website www.schneider-electric.com for selection.
 (4) ● represents T, reference is available with thermal pad (ends with T) or without thermal pad (does not end with T) options.
 (5) Available with smart diagnostic feature (built-in visual indicator and alarm output enables quick response to unexpected results and correct monitoring of SSR operation), reference ends with S (e.g. SSP1A125BDS).

Harmony Relay SSM and SSD solid state relays



SSM modular DIN rail solid state relays (DC switching)

Contact	1 NO			
Load current	6 A		12 A	
Load voltage	1...60 VDC	1...100 VDC	1...60 VDC	1...100 VDC
Frontal width	12 mm		18 mm	
Complete product	4...32 VDC	SSM1D26BD	SSM1D36BD	SSM1D212BD SSM1D312BD

SSM modular DIN rail solid state relays (random switching)

Contact	1 NO				2 NO	
Load current	6 A		12 A		6 A	
Load voltage	24...280 VAC	48...600 VAC	24...280 VAC	48...600 VAC	24...280 VAC	48...600 VAC
Frontal width	12 mm			18 mm		
Complete product	4...32 VDC	SSM1A16BDR	SSM1A36BDR	SSM1A112BDR SSM1A312BDR	SSM2A16BDR	SSM2A36BDR
	18...36 VAC	SSM1A16B7R	–	SSM1A112B7R SSM1A312B7R	–	–
	90...140 VAC	–	–	SSM1A112F7R SSM1A312F7R	–	–
	200...265 VAC	–	–	SSM1A112P7R SSM1A312P7R	–	–

SSM modular DIN rail solid state relays (zero voltage switching)

Contact	1 NO				2 NO	
Load current	6 A		12 A		6 A	
Load voltage	24...280 VAC	48...600 VAC	24...280 VAC	48...600 VAC	24...280 VAC	
Frontal width	12 mm			18 mm		
Complete product	4...32 VDC	SSM1A16BD	SSM1A36BD	SSM1A112BD SSM1A312BD	SSM2A16BD	
	90...140 VAC	SSM1A16F7	–	SSM1A112F7 SSM1A312F7	–	
	200...265 VAC	SSM1A16P7	–	SSM1A112P7	–	



SSD modular DIN rail solid state relays (zero voltage switching)

Contact	1 NO							
Output voltage	48...600 VAC							
Frontal width	22.5 mm				45 mm			
Load current	20 A		35 A		45 A		60 A	
Control voltage	4...32 VDC	90...280 VAC/VDC	4...32 VDC	90...280 VAC/VDC	4...32 VDC	90...280 VAC/VDC	4...32 VDC	90...280 VAC/VDC
Configura- tion	Relay	SSD1A320BDC1	SSD1A320M7C1	SSD1A335BDC1	SSD1A335M7C1	–	–	–
	Contactor - Screw	SSD1A320BDC2	SSD1A320M7C2	SSD1A335BDC2	SSD1A335M7C2	SSD1A345BDC2	SSD1A345M7C2	SSD1A360BDC2 SSD1A360M7C2
	Contactor - Spring	SSD1A320BDC3	SSD1A320M7C3	SSD1A335BDC3	SSD1A335M7C3	SSD1A345BDC3	SSD1A345M7C3	SSD1A360BDC3 SSD1A360M7C3

SSD modular DIN rail solid state relays (random switching)

Contact	1 NO							
Output voltage	48...600 VAC							
Frontal width	22.5 mm				45 mm			
Load current	20 A		35 A		45 A		60 A	
Control voltage	4...32 VDC	90...280 VAC/VDC	4...32 VDC	90...280 VAC/VDC	4...32 VDC	90...280 VAC/VDC	4...32 VDC	90...280 VAC/VDC
Configura- tion	Relay	SSD1A320BDR1	SSD1A320M7R1	SSD1A335BDR1	SSD1A335M7R1	–	–	–
	Contactor - Screw	SSD1A320BDR2	SSD1A320M7R2	SSD1A335BDR2	SSD1A335M7R2	SSD1A345BDR2	SSD1A345M7R2	SSD1A360BDR2 SSD1A360M7R2
	Contactor - Spring	SSD1A320BDR3	SSD1A320M7R3	SSD1A335BDR3	SSD1A335M7R3	SSD1A345BDR3	SSD1A345M7R3	SSD1A360BDR3 SSD1A360M7R3

SSD modular DIN rail solid state relays (DC switching)

Contact	1 NO	
Output voltage	1...200 VDC	
Control voltage	4...32 VDC	
Frontal width	22.5 mm	
Load current	20 A	30 A
Relay configuration	SSD1D520BDC1	SSD1D530BDC1

Harmony Relay RM17, RM22, and RM35 control relays (1)



1 3-phase monitoring relays for DIN rail mounting

Phase loss and sequence	Yes						
Asymmetry	–	Yes	–	Yes	–	Yes	–
Undervoltage	–	–	Yes	–	–	–	–
> U > window mode	–	–	–	–	–	Yes	–
Measuring range	183...528 VAC	183...484 VAC	183...528 VAC	183...528 VAC	160...288 VAC	183...528 VAC	304...576 VAC
Output contacts/Current	1 CO/5 A	2 CO/5 A	1 CO/5 A		2 CO/8 A	1 CO/5 A	2 CO/8 A
Power supply	Self-powered						
Frontal width	17.5 mm			22.5 mm		17.5 mm	22.5 mm
Complete product	RM17TG00	RM17TG20	RM17TA00	RM17TU00	RM22TU21	RM17TE00	RM22TR33

2 3-phase monitoring relays with NFC technology for DIN rail mounting

Phase loss and sequence	Yes
Asymmetry	Yes
Overvoltage and undervoltage	Yes
Overfrequency and underfrequency	Yes
Measuring range	166...576 VAC
Output contact	2 CO/8 A
Power supply	208...480 VAC
Frontal width	22.5 mm
Complete product	RMNF22TB30

3 3-phase voltage monitoring relays for DIN rail mounting

Detected loss of one or more phases	Yes		
Absence of neutral	–	Yes	–
Overvoltage and undervoltage	Yes		
Measuring range	183...528 VAC	114...329 VAC	194...528 VAC
Output contacts/Current	1 CO/5 A	1 CO/5A for > U threshold + 1 CO/5A for < U threshold	
Power supply	Self-powered		
Frontal width	17.5 mm	35 mm	
Complete product	RM17UB310	RM35UB3N30	RM35UB330

4 Phase or DC voltage monitoring relays for DIN rail mounting

> U > window mode	Yes						
Overvoltage	Yes						–
Undervoltage	Yes						–
Measuring range	65...260 VAC/VDC	20...80 VAC/VDC	0.05...5 VAC/VDC	1...100 VAC/VDC	15...500 VAC/VDC	15...500 VAC/VDC	80...300 VAC/VDC
Output contacts/Current	1 CO/5 A			2 CO/8 A			
Power supply	Self-powered			24...240 VAC		380...415 VAC	110...240 VAC
Frontal width	17.5 mm			22.5 mm			
Complete product	RM17UBE15	RM17UBE16	RM22UA31MR	RM22UA32MR	RM22UA33MR	RM22UA33MT	RM22UB34



5 Current monitoring relays for DIN rail mounting

Monitoring characteristics	Overcurrent	> I > window mode with/without memory					
Integrated current transformer	Yes	–					
Measuring range	2...20 A	4...1,000 mA	2...500 mA	0.15...15 A			
Output contacts/Current	1 CO/5 A	2 CO/8 A	2 CO/5 A		2 CO/8 A		
Power supply	24...240 VAC/VDC					380...415 VAC	
Frontal width	17.5 mm	22.5 mm	35 mm				
Complete product	RM17JC00MW	RM22JA31MR	RM35JA31MW	RM35JA32MW	RM35JA32MR	RM35JA32MT	

6 Level monitoring relays for DIN rail mounting

Level monitoring by	Resistive probe					Discrete sensor	
Measuring range	5...100 kΩ		25 Ω...1 MΩ			–	
Output contacts/Current	1 CO/8 A		2 CO/8 A	2 CO/5 A	1 CO/5 A		
Power supply	24...240 VAC/VDC	380...415 VAC	24...240 VAC/VDC	24...240 VAC/VDC	24...240 VAC/VDC		
Frontal width	22.5 mm			35 mm			
Complete product	RM22LG11MR	RM22LG11MT	RM22LA32MR	RM35LM33MW	RM35LV14MW		

(1) Please consult our general catalog for other application relays available for motor temperature monitoring and pump, frequency, speed, or temperature control.

Harmony Relay RE17, RE22, REXL, and RE48 electronic timing relays

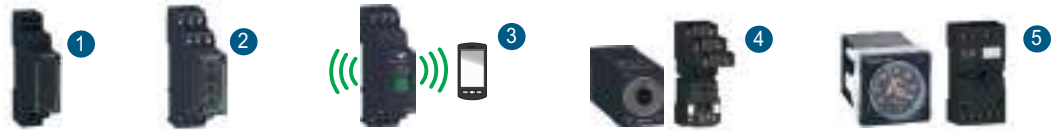

1 Timing relays with screw/spring terminals for DIN rail mounting, 1 contact						
Type	1 function	2 functions	2 functions	1 function	Multifunction	Multifunction
Functions (1)	A	A, At	L, Li	C	A, At, B, C, H, Ht, D, Di, Ac, Bw	Ad, Ah, N, O, P, Pt, T, Tt, W
Timing range	0.1 s...100 h					
Type of output/current	1 solid state 0.7 A	1 relay output 1 CO/8 A				
Power supply	24...240 VAC/VDC	24 VDC, 24...240 VAC			12...240 VAC/VDC	24 VDC, 24...240 VAC
Frontal width	17.5 mm					
Complete product	Screw terminal	RE17LAMW	RE17RAMU	RE17RLMU	RE17RCMU	RE17RMMW
	Spring terminal	RE17LAMWS	RE17RAMUS	RE17RLMUS	RE17RCMUS	RE17RMMWS
2 Timing relays with screw terminals for DIN rail mounting, 2 contacts						
Type	3 functions	2 functions	Multifunction			
Functions (1)	A, At, Aw	C, Ct	A, At, Aw, C, Ct, D, Dt, Dw, Di, Dit, Diw, H, Ht, Hw, Qg, Qgt, Qgw, Qt, Qtt, Qtw, W, Wt			
Timing range	0.05 s...300 h					
Type of output/current	2 CO/8 A					
Power supply	24 VDC, 24...240 VAC					
Frontal width	22.5 mm					
Complete product	RE22R1MAMR	RE22R2CMR	RE22R2MYMR			
3 Timing relays with NFC technology for DIN rail mounting, screw terminals, 2 contacts						
Type	Multifunction					
Functions (1)	A, Ac, Ad, Ah, Ak, At, B, Bw, C, D, Di, Dt, Dit, H, Ht, L, Li, Lt, Lit, N, O, P, Pt, Qt, Qtt, Tl, Tt, W					
Timing range	0.1 s...999 h					
Type of output/current	2 CO/8 A					
Power supply	24...240 VDC/VAC					
Frontal width	22.5 mm					
Complete product	RENF22R2MMW					
4 Miniature plug-in timing relays for DIN rail mounting						
Function (1)	A (power on-delay)					
Timing range	0.1 s...100 h					
Type of output/current	2 CO/5 A			4 CO/5 A		
Power supply	24 VDC	120 VAC	230 VAC	24 VDC	120 VAC	230 VAC
Dimension	21 x 27 mm miniature plug-in					
Complete product	REXL2TMBD	REXL2TMF7	REXL2TMP7	REXL4TMBD	REXL4TMF7	REXL4TMP7
Screw connector socket (2)	RXZE2S108M		RXZE2S114M			
5 48 x 48 mm analog plug-in (8-pin) timing relays for DIN rail or front panel mounting						
Type	1 function	4 functions	2 functions	4 functions		
Functions (1)	A	A1, A2, H1, H2	L, Li	A, B, C, Di		
Timing range	0.02 s...300 h					
Type of output/current	1 CO/5 A	1 + 1 (instant.)/5 A	2 CO/5 A			
Power supply	24...240 VAC/VDC					
Dimension	48 x 48 mm analog panel-mounted or plug-in					
Complete product	RE48ATM12MW	RE48AMH13MW	RE48ACV12MW	RE48AML12MW		
Screw connector socket (3)	RUZC2M			RUZC3M		

A: power on-delay relay
 Ac: on-delay & off-delay relay (4)
 Act: on-delay & off-delay relay (4) (5)
 Ad: pulse delayed relay (4)
 Ah: pulse delayed relay (single cycle) (4)
 Ak: asymmetrical on-delay & off-delay relay (4)
 Akt: asymmetrical on-delay & off-delay relay (4) (5)
 At: power on-delay relay (5)
 Aw: power on-delay relay with retrigger/restart control signal
 A1: power on-delay relay (R1 instantaneous, R2 timed)
 A2: power on-delay relay (both R1/R2 timed)
 B: interval relay (4)
 Bw: double interval relay (4)
 C: off-delay relay (4)
 Ct: off-delay relay (5)
 D: symmetrical flashing relay (starting pulse-off)
 Di: symmetrical flashing relay (starting pulse-on)
 Dit: symmetrical flashing relay (starting pulse-on) (5)
 Diw: symmetrical flashing relay (starting pulse-on) with retrigger/restart control signal
 Dt: symmetrical flashing relay (starting pulse-off) (5)
 Dw: symmetrical flashing relay (starting pulse-off) with retrigger/restart control signal
 H: interval relay
 He: pulse on de-energization relay
 Ht: interval relay (5)
 Hw: interval relay with retrigger/restart control signal
 H1: interval relay (R1 instantaneous, R2 timed)
 H2: interval relay (both R1/R2 timed)
 K: delay on de-energization relay (without auxiliary supply)
 L: asymmetrical flashing relay (starting pulse-off)
 Li: symmetrical flashing relay (starting pulse-on)
 Lt: symmetrical flashing relay (5)
 N: safeguard relay
 O: delayed safeguard relay
 P: pulse delayed relay with fixed pulse length
 Pt: pulse delayed relay with fixed pulse length (5)
 Qc: star-delta timing relay, 1 CO output
 Qe: star-delta timing relay, 1 NC + 1 NO output & split common
 Qg: star-delta timing relay, 2 CO outputs & same common
 Qgt: star-delta timing relay, 2 CO outputs & same common (5)
 Qt: star-delta timing relay, 2 CO outputs & split common
 Qtt: star-delta timing relay, 2 CO outputs & split common (5)
 Tt: retriggerable bistable relay with control signal on
 W: interval relay with control signal off
 Wt: interval relay with control signal off (5)

(1) For more details about functions, please refer to the technical descriptions and schemes on our website www.schneider-electric.com.
 (2) With separate contacts
 (3) With mixed contacts
 (4) With control signal
 (5) With pause-summation control signal



06. Modicon PLC, power supply and transformer, Uninterruptible Power Supply

Modicon PLC: M221



Modicon M221 logic controllers										
Applications		Control of simple machines								
Supply voltage		100-240 V ~	24 V $\overline{\text{DC}}$	24 V $\overline{\text{DC}}$	100-240 V ~	24 V $\overline{\text{DC}}$	24 V $\overline{\text{DC}}$	100-240 V ~	24 V $\overline{\text{DC}}$	24 V $\overline{\text{DC}}$
Inputs/ outputs	Logic inputs/ outputs	16 logic I/O			24 logic I/O			40 logic I/O		
	No. and type of inputs	9 sink/source 24 V $\overline{\text{DC}}$ inputs, inc. 4 high-speed inputs			14 sink/source 24 V $\overline{\text{DC}}$ inputs, inc. 4 high-speed inputs			24 sink/source 24 V $\overline{\text{DC}}$ inputs, inc. 4 high-speed inputs		
	No. and type of outputs	7 relay outputs	7 source transistor outputs, inc. 2 high-speed outputs	7 sink transistor outputs, inc. 2 high-speed outputs	10 relay outputs	10 source transistor outputs, inc. 2 high-speed outputs	10 source transistor outputs, inc. 2 high-speed outputs	16 relay outputs	16 source transistor outputs, inc. 2 high-speed outputs	16 sink transistor outputs, inc. 4 high-speed outputs
	Connection of logic I/O	On removable screw terminal block								
	Analog inputs	2 x 0...10 V analog inputs								
Connection of analog inputs		On dedicated removable connector								
Logic controller	No Ethernet port	TM221C16R	TM221C16T	TM221C16U	TM221C24R	TM221C24T	TM221C24U	TM221C40R	TM221C40T	TM221C40U
	With embedded Ethernet port	TM221CE16R	TM221CE16T	TM221CE16U	TM221CE24R	TM221CE24T	TM221CE24U	TM221CE40R	TM221CE40T	TM221CE40U



Modicon M221 Book logic controllers			
Applications		Control of simple machines	
Supply voltage		24 V $\overline{\text{DC}}$	
Inputs/ outputs	Logic inputs/ outputs	16 logic I/O	16 logic I/O
	No. and type of inputs	8 sink/source 24 V $\overline{\text{DC}}$ inputs, inc. 4 high-speed inputs	8 sink/source 24 V $\overline{\text{DC}}$ inputs, inc. 4 high-speed inputs
	No. and type of outputs	8 relay outputs	8 source transistor outputs, inc. 2 high-speed outputs
	Connection of logic I/O	On removable screw terminal block or spring terminal block (1)	On HE 10 connector (with the Telefast Modicon ABE7 pre-wired system: connection cables and sub-bases)
	Analog inputs	2 x 0...10 V analog inputs	
Connection of analog inputs		On dedicated removable connector	
Logic controller	No Ethernet port	TM221M16R	TM221M16T
		TM221M16RG (1)	TM221M16TG (1)
	With embedded Ethernet port	TM221ME16R	TM221ME16T
		TM221ME16RG (1)	TM221ME16TG (1)

(1) Spring terminal block on references ending in the letter G

Modicon power supplies and transformers



Regulated switch mode power supplies 10 to 480 W for mounting on rail

Power		10 to 60 W			50 to 480 W		
Input voltage		100...240 V ~			100...240 V ~ and 140...340 V ~ (2)		
Certifications (1)		CE marking, CB Scheme, cULus listed, CULus recognized, RCM, EAC, NEC class 2 (3)					
Housing		Modular			Book		
Output voltage		5 V ~	12 V ~	24 V ~	12 V ~	24 V ~	48 V ~
Reference (according to output current)	0.4 A	-	-	ABLM1A24004	-	-	-
	0.6 A	-	-	ABLM1A24006	-	-	-
	1 A	-	ABLM1A12010	-	-	-	-
	1.2 A	-	-	ABLM1A24012	-	-	-
	2.1 A	-	ABLM1A12021	-	-	-	-
	2.1 A	-	-	-	-	ABLS1A24021	-
	2.5 A	-	-	ABLM1A24025	-	-	ABLS1A48025
	3.1 A	-	-	-	-	ABLS1A24031	-
	3.6 A	ABLM1A05036	-	-	-	-	-
	3.8 A	-	-	-	-	ABLS1A24038	-
	4.2 A	-	ABLM1A12042	-	-	-	-
	5 A	-	-	-	-	ABLS1A24050	-
	6.2 A	-	-	-	-	ABLS1A12062	-
	10 A	-	-	-	-	ABLS1A12100	ABLS1A24100
20 A	-	-	-	-	-	ABLS1A24200	



6

Regulated switch mode power supplies 72 to 960 W for mounting on rail (wide input voltage range)

Input voltage		100...120 V ~ and 200...500 V ~ (4)		380...500 V ~	
Certifications (1)		CE marking, UL (508), CSA (60950-1), CB Scheme, EAC, RCM, KC			
Compatibility	With function modules	Yes with all Modicon power supply function modules (5)			
Output voltage		24 V ~			
Reference (according to output current)	3 A	ABL8RPS24030		-	
	5 A	ABL8RPS24050		-	
	10 A	ABL8RPS24100		-	
	20 A	ABL8RPM24200		ABL8WPS24200	
	40 A	-		ABL8WPS24400	

(1) Please consult detail on certifications for each reference in the individual datasheet available on our website www.schneider-electric.com.

(2) Depending on product reference, consult our product datasheet on www.schneider-electric.com.

(3) NEC class 2 for book only for ABLM●●, ABL1A24021, ABL1A24031, and ABL1A24038.

(4) Except ABL8RPM24200: 100...240 V and 200...240 V ~.

(5) Compatible modules: buffer module, batteries and battery control modules, redundancy module, and discriminating downstream protection module.

For more information, see the Modicon power supply catalog on our website www.schneider-electric.com.

Modicon power supplies and transformers



Function modules for continuity of service (only compatible with ABL8RP/ABL8WP power supplies)

Type of function	Battery modules (2) (3)	Solutions to microbreaks and power outages (3)	Redundancy module
Input voltage	24 V ~		
Certifications (1)	CE marking, UL (508), CSA (60950-1), EAC, RCM		
Compatibility	With power supplies	Yes, but only with ABL8RP/ABL8WP Modicon power supply	
Output voltage	24 V ~		
Reference (according to output current)	3 Ah	ABL8BPK24A03	–
	7 Ah	ABL8BPK24A07	–
	12 Ah	ABL8BPK24A12	–
	20 A	–	ABL8BBU24200
	40 A	–	ABL8BBU24400



Regulated switch mode power supplies 100 to 240 W for mounting on panel (4)

Input voltage	100...240 V ~		
Certifications (1)	CE marking, CB Scheme, cULus listed, UL us recognized, RCM, EAC		
Output voltage	12 V ~	24 V ~	
Reference (according to output current)	4.5 A	–	ABLP1A24045
	6.2 A	–	ABLP1A24062
	8.5 A	ABLP1A12085	–
	10 A	–	ABLP1A24100

(1) Please consult detail on certifications for each reference in the individual datasheet available on our website www.schneider-electric.com.
 (2) Supplied with 20 or 30 A fuse, depending on the model.
 (3) Holding time depending on the load. Please refer to the table of compatibility of battery module with holding time in the Modicon power supply catalog on our website www.schneider-electric.com.
 (4) Mounting on DIN rail possible with additional accessories; ABLP1A01 for all references except ABLP1A24100, ABLP1A02 for ABLP1A24100.

Modicon power supplies and transformers

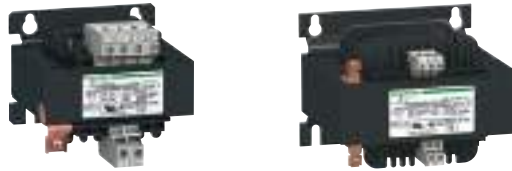

Single winding transformers

Operating temperature		40 °C	50 °C		
Input voltage		230 V ~		230 V ~ and 400 V ~	
Applications		SELV transformer (2)		Isolation transformer	
Certifications (1)		CE marking, EAC		CEus, CE marking, UL (506), EAC	
Output voltage		24 V ~			230 V ~
Reference (according to nominal power)	25 VA	–	ABL6TS02B	–	
	40 VA	ABT7ESM004B	ABL6TS04B	ABL6TS04U	
	63 VA	ABT7ESM006B	ABL6TS06B	ABL6TS06U	
	100 VA	ABT7ESM010B	ABL6TS10B	ABL6TS10U	
	160 VA	ABT7ESM016B	ABL6TS16B	ABL6TS16U	
	250 VA	ABT7ESM025B	ABL6TS25B	ABL6TS25U	
	400 VA	–	ABL6TS40B	ABL6TS40U	
	630 VA	–	ABL6TS63B	ABL6TS63U	
	1,000 VA	–	ABL6TS100B	ABL6TS100U	
	1,600 VA	–	–	ABL6TS160U	
2,500 VA	–	–	ABL6TS250U		

(1) Please consult detail on certifications for each reference in the individual datasheet available on our website www.schneider-electric.com.

(2) SELV = Safety Extra Low Voltage.

Note: Please consult the Modicon power supply catalog on our website www.schneider-electric.com for a wider choice of power supplies or transformers.

Uninterruptible Power Supply (UPS)



Schneider Electric Industrial UPS - 24 V AC DIN Rail

Power Capacity	240 W	480 W
Input/Output	Hardwire/24 V AC	
Input voltage range	21.6 to 28.6 V AC	
Mounting type	DIN rail mount	
Runtime	10 mins @ 10 A	5 mins @ 20 A
Communication	I/O Relay, LEDs	
Number of batteries in parallel	4	
Safety Certifications	UL, TUV, CE and UKCA listed	



Easy UPS

Series	1 Ph BVS Series	1 Ph SMV Series
Nominal Input Voltage Input Frequency	230 V 50/60 Hz (Auto sensing)	
Nominal Output Voltage Output Frequency	230 V ~ 50 Hz or 60 Hz +/- 1 Hz	
Power Capacity	300 W/500 VA to 600 W/1,000 VA	525 W/750 VA to 2,100 W/3,000 VA
Topology	Line interactive	
Battery type	Maintenance-free sealed lead-acid battery	



Easy UPS 1 Ph On-line

Model	SRV 1,000 VA	SRV 2,000 VA	SRV 3,000 VA	SRV 6,000 VA	SRV 10,000 VA
Nominal Input Voltage Input Frequency	230 V ~ 50/60 Hz				
Output Voltage Frequency	220/230/240 V ~ 50/60 Hz +/-0.5%			220/230/240 V ~ 50/60 Hz +/-0.1%	
Output Power Capacity (Watts/VA)	800 W/1,000 VA	1,600 W/2,000 VA	2,400 W/3,000 VA	6,000 W/6,000 VA	10,000 W/10,000 VA
Topology	Online				
Mounting type	Rack & Tower				
Battery type	Maintenance-free sealed lead-acid battery				

(1) For more information depending on product reference, consult our product datasheet on www.schneider-electric.com.



07. Harmony safety modules and Modicon safety controllers

Harmony safety modules

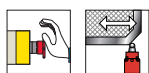

Function: Emergency stop, guard switch

Harmony safety modules conforming to Cat. 3, PL e, SIL3, and STOP category 0

Terminal type	Captive screw clamp terminal	
Connections	Removable from module	
Number of instantaneous safety output contacts	3 NO	3 NO
Number of additional output contacts	1 solid state	1 solid state
Reference	24 VAC/VDC	XPSBAC14AP
	48...240 VAC/DC	XPSBAC34AP
		XPSBAC14AC
		XPSBAC34AC



Function: Emergency stop, switch monitoring, protective guard applications, coded magnetic switch monitoring, safety mats/edges, safety light curtain or RFID switch monitoring

Harmony safety modules conforming to Cat. 4, PL e, SILCL3, STOP category 0 (for XPSUAK) and STOP category 1 (for XPSUAT)

Terminal type	Captive screw clamp terminal		Spring clamp terminal	
Connections	Removable from module			
Number of instantaneous safety circuits	3 NO	2 NO + 1 NC	3 NO	2 NO + 1 NC
Number of delayed or immediate contacts	3 NO + 1 NC	–	3 NO + 1 NC	–
Number of additional outputs	1 solid state + 1 pulsed diagnostic output	1 pulsed diagnostic output	1 solid state + 1 pulsed diagnostic output	1 pulsed diagnostic output
Reference	24 VAC/VDC	–	XPSUAK12AP	XPSUAK12AC
		0...15 min	XPSUAT13A3AP	XPSUAT13A3AC
	48...240 VAC/DC	–	XPSUAK32AP	XPSUAK32AC
		0...15 min	XPSUAT33A3AP	XPSUAT33A3AC

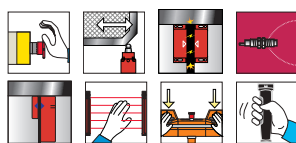

Function: Emergency stop, protective guard, enabling switch or two-hand control monitoring, coded magnetic switch, SIL2 proximity switches, safety light curtain or RFID switch monitoring (1) (2)

Harmony safety modules conforming to Cat. 4, PL e, SILCL3, STOP category 0

Terminal type	Captive screw clamp terminal		Spring clamp terminal
Connections	Removable from module		
Type conforming to standard EN5074	IIIA or IIIC		IIIA or IIIC
Number of instantaneous safety circuits	2 NO		2 NO
Maximum number of two-hand control or enabling switch monitoring (Cat. 4, PL e, SIL3)	1		1
Maximum number of safety light curtain or RFID switch monitoring (Cat. 4, PL e, SIL3)	2		2
Maximum number of safety coded magnetic switches or other safety devices (Cat. 4, PL e, SIL3)	2		2
Number of additional outputs	1 pulsed diagnostic output		1 pulsed diagnostic output
Reference	24 VAC/VDC	XPSUS12AP	XPSUS12AC
	48...240 VAC/VDC	XPSUS32AP	XPSUS32AC

(1) Enabling switch and two-hand control with automatic start only.

(2) Can also be used with XY2SB71 or XY2SB714 two-hand control stations.

Harmony safety modules

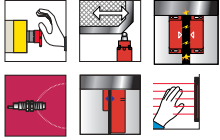

Function: Emergency stop, switch monitoring, protective guard applications, coded magnetic switch monitoring, safety light curtain or RFID switch monitoring

Harmony safety modules conforming to Cat. 4, PL e, SILCL3, STOP category 0

Terminal type	Captive screw clamp terminal	Spring clamp terminal
Connections	Removable from module	
Number of instantaneous safety circuits	3 NO	3 NO
Number of additional outputs	1 pulsed diagnostic output	1 pulsed diagnostic output
Reference	24 VAC/VDC	XPSUAF13AP
	48...240 VAC/VDC	XPSUAF33AP
		XPSUAF13AC
		XPSUAF33AC

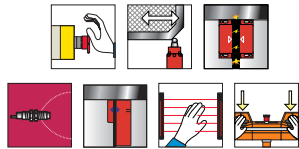

Function: Emergency stop, switch monitoring, or two-hand control monitoring (1)

Harmony safety modules conforming to Cat. 1, PL c, SILCL1, STOP category 0

Terminal type	Captive screw clamp terminal	Spring clamp terminal
Connections	Removable from module	
Type conforming to standard EN5074	IIIA	IIIA
Number of instantaneous safety circuits	1 NO	1 NO
Number of additional outputs	1 NC + 1 pulsed diagnostic output	1 NC + 1 pulsed diagnostic output
Reference	24 VAC/VDC	XPSUAB11CP
	48...240 VAC/VDC	XPSUAB31CP
		XPSUAB11CC
		XPSUAB31CC

(1) Two-hand control with automatic start only.

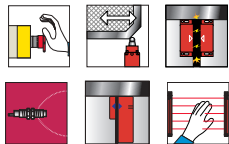

Function: Emergency stop, switch monitoring, protective guard applications, coded magnetic switch monitoring, safety light curtain or RFID switch monitoring

Harmony safety modules conforming to Cat. 4, PL e, SILCL3, STOP category 0

Terminal type	Captive screw clamp terminal	Spring clamp terminal
Connections	Removable from module	
Number of instantaneous safety circuits	3 NO + 1 NC	3 NO + 1 NC
Maximum number of safety functions for Cat. 4, PL e, SIL3	6	6
Number of additional outputs	1 pulsed diagnostic output	1 pulsed diagnostic output
Reference	24 VAC/VDC	XPSUDN13AP
	48...240 VAC/VDC	XPSUDN33AP
		XPSUDN13AC
		XPSUDN33AC

Harmony safety modules

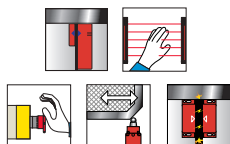

Function: Emergency stop, switch monitoring and protective guard applications

Harmony safety modules conforming to Cat. 4, PL e, SIL3, and STOP category 1

Terminal type	Captive screw clamp terminal	Spring clamp terminal
Connections	Removable from module	
Number of instantaneous safety output contacts	2 NO	
Number of delayed or immediate output contacts	1 NO	
Number of additional outputs	50...500 mV	
Reference	24 VAC/DC	0...15 min
	XPSBAT12A1AP	XPSBAT12A1AC

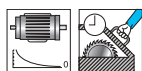

Function: Zero speed monitoring with delayed access to dangerous area

Harmony safety modules conforming to Cat. 3, PL e, SIL3, and STOP category 1

Terminal type	Captive screw clamp terminal	Spring clamp terminal
Connections	Removable from module	
Number of safety delayed output contact	1 NO (1)	
Number of additional outputs	1 Solid-state + 1 pulsed diagnostic output	
Voltage threshold selection	50...500 mV	
Time delay selection	0.5...60 s	
Reference	24 VAC/DC	
	XPSUVN11AP	XPSUVN11AC
	48...240 VAC/DC	
	XPSUVN31AP	XPSUVN31AC



Function: Increasing the number of safety contacts (2)

Harmony safety modules conforming to Cat. 4, PL e, SILCL3, STOP category 0

Terminal type	Captive screw clamp terminal	Spring clamp terminal
Connections	Removable from module	
Number of instantaneous safety circuits	4 NO	4 NO
Number of additional outputs	2 NC	2 NC
Reference	24 VAC/VDC	
	XPSUEP14AP	XPSUEP14AC
	48...240 VAC/VDC	
	XPSUEP34AP	XPSUEP34AC

(1) To increase the number of safety delayed output contacts, please refer to XPSUEP range extension outputs.

(2) This module can be used with just XPSU safety modules and is mounted via a side expansion connection included with the product, expect for XPSUAB.

Modicon MCM modular safety controllers



Safety controllers CPU

Safety controllers conforming to Cat. 4, PL e, SIL3

Description	Safety controller CPU	CPU + backplane connector	Safety controller CPU	CPU + backplane connector	
Connections	Removable from controller				
Number and type of inputs	8 digital inputs + 2 for Start/Restart interlock		8 digital inputs + 4 for Start/Restart interlock		
Number and type of outputs	2 OSSD pairs + 4 test outputs + 2 status outputs		4 OSSD + 4 test outputs + 4 status outputs		
Terminal type	Screw (1)				
Reference	24 VDC	XPSMCMCP0802	XPSMCMCP0802BC	XPSMCMC10804	XPSMCMC10804BC



Safe expansion modules

Safe expansion I/O modules

Description	Safe mixed I/O expansion modules		Safe input expansion modules				
Number and type of inputs	8 digital inputs + 2 for Start/Restart interlock	8 digital inputs + 4 for Start/Restart interlock	8 digital inputs	16 digital inputs	12 digital inputs	4-channel analogic inputs 0...20 mA/0...10 V	
Number and type of outputs	2 OSSD pairs + 4 test outputs + 2 status outputs	4 single OSSD + 4 test outputs + 4 status outputs	4 test outputs	4 test outputs	8 test outputs for 4-wire safety mats	–	
Resolution	–					16 bits	
Terminal type	Screw (1)						
Reference	24 VDC	XPSMCMMX0802	XPSMCMMX0804 (2)	XPSMCMMDI0800	XPSMCMMDI1600	XPSMCMMDI1200MT	XPSMCMMAI0400 (2)



Safe output expansion modules

Description	Safe digital expansion modules		Safe relay output modules (without expansion bus connection, wired externally)		Safe relay output modules (with expansion bus connection)		
Number and type of inputs	2 for Start/Restart interlock	4 for Start/Restart interlock	1 for Start/Restart interlock	2 for Start/Restart interlock	4 for Start/Restart interlock		
Number and type of outputs	2 OSSD pairs + 2 status outputs	4 OSSD pairs + 4 status outputs	2 relays for 1 output (2 NO + 1 NC)	4 relays for 2 independent outputs (4 NO + 2 NC)	4 relays	4 relays with 8 status outputs	
Terminal type	Screw (1)						
Reference	24 VDC	XPSMCMDO0002	XPSMCMDO0004	XPSMCMER0002	XPSMCMER0004	XPSMCMRO0004	XPSMCMRO0004D



Safe speed monitoring modules

Description	Safe speed monitoring modules					
Number and type of inputs	- 1 Sin/Cos encoder and 2 proximity sensor inputs	- 2 Sin/Cos encoders and 2 proximity sensor inputs	- 1 TTL encoder and 2 proximity sensor inputs	- 2 TTL encoders and 2 proximity sensor inputs	- 1 HTL encoder and 2 proximity sensor inputs	- 2 HTL encoders and 2 proximity sensor inputs
Connector type	- 1x RJ 45 (ENC1) - Proximity sensor connection via terminal blocks	- 2x RJ 45 (ENC1/ENC2) - Proximity sensor connection via terminal blocks	- 1x RJ 45 (ENC1) - Proximity sensor connection via terminal blocks	- 2x RJ 45 (ENC1/ENC2) - Proximity sensor connection via terminal blocks	- 1x RJ 45 (ENC1) - Proximity sensor connection via terminal blocks	- 2x RJ 45 (ENC1/ENC2) - Proximity sensor connection via terminal blocks
Terminal type	Screw (1)					
Reference	XPSMCMEN0100SC	XPSMCMEN0200SC (3)	XPSMCMEN0100TT	XPSMCMEN0200TT	XPSMCMEN0100HT	XPSMCMEN0200HT

(1) References are given for products with a screw connector. For equivalent references with a spring clamp connector, add a "G" at the end of the reference. For example, XPSMCMMX0802 becomes XPSMCMMX0802G.

(2) Modules can be used with just the CPU XPSMCMC10804 or XPSMCMC10804BC CPU (screw or spring terminal type).

(3) When monitoring of only 2 proximity sensors is required, order an XPSMCMEN0200.

Modicon MCM modular safety controllers



Safe expansion modules (continued)

Safe communication expansion modules		
Description	Safe RS 485 bus expansion module for remote extension	
Characteristics	1 connection interface: single channel transmitter/receiver network connection	2 connections interface: dual channel transmitter/receiver network connection
Terminal type	Screw (1)	
Reference	XPSMCMCO0000S1	XPSMCMCO0000S2



Non-Safe communication modules

Description	Non-Safe communication modules					
Fieldbus/network type	CANopen	Ethernet IP	EtherCAT	Modbus Serial (RTU)	Modbus TCP	Profibus DP
Fieldbus connector type	SUB-D 9-way (female)	1x RJ 45 (in/out)	2x RJ 45 (in/out)	1x RJ 45	1x RJ 45 (in/out)	SUB-D 9-way (male)
Terminal type	Screw (1)					
Reference	XPSMCMCO0000CO	XPSMCMCO0000EI	XPSMCMCO0000EC	XPSMCMCO0000MB	XPSMCMCO0000EM	XPSMCMCO0000PB

Software

Description	SoSafe configurable software
Application	To configure a logic connection between the inputs and outputs of the XPSMCMCP0802 and XPSMCMC10804 safety controller CPU (4) and the components of the application being developed
PC hardware requirements	RAM: 256 MB, Hard disk ≥ 300 MB of free space USB connector: 1.1 or 2.0, CD-ROM drive
PC software requirements	Windows XP with Service Pack 3 installed or Windows Vista, 32-bit, or Windows 7 or 8.1, 32-bit and 64-bit Microsoft Framework 3.5 installed on the PC
Reference	Free software available to download from www.se.com



Accessories

Description	Backplane expansion connector (2)	Memory card
Application	To connect the various expansion modules to the safety controller CPU	To save configuration data for subsequent transfer to a new device without using a PC
Reference	XPSMCMCN0000SG	XPSMCMME0000



Description	Configuration cable	RS 485 shielded cables			Encoder splitter cables	
Use	For software configuration, between a PC, the safety controller CPU, and the fieldbus communication modules. Equipped with 2x USB connectors: USB A and USB mini B	Between two Safe communication expansion modules			Between SIN/ COS safe speed monitoring module and PacDrive M drives and the associated servo motors	Between SIN/ COS safe speed monitoring modules and Lexium 62 (PacDrive 3), Lexium 32 servo drives and the associated servo motors
Reference	TCSXCNAMUM3P	TSXSCMCN010	TSXSCMCN025	TSXSCMCN050	TSXESPPM001 (3)	TSXESPP3001 (3)

(1) References are given for products with a screw terminal. For equivalent references with a spring clamp connector, add a "G" at the end of the reference. For example, XPSMCMCO0000S1 becomes XPSMCMCO0000S1G.

(2) This connector only needs to be ordered for the XPSMCMCP0802 or XPSMCMC10804 safety controller when it is connected to expansion modules.

(3) With 1 m cable. For other cable lengths, replace the last number of the reference with 3 for a 3 m cable or 5 for a 5 m cable.

(4) Consider all CPUs with screw and spring clamp terminals.

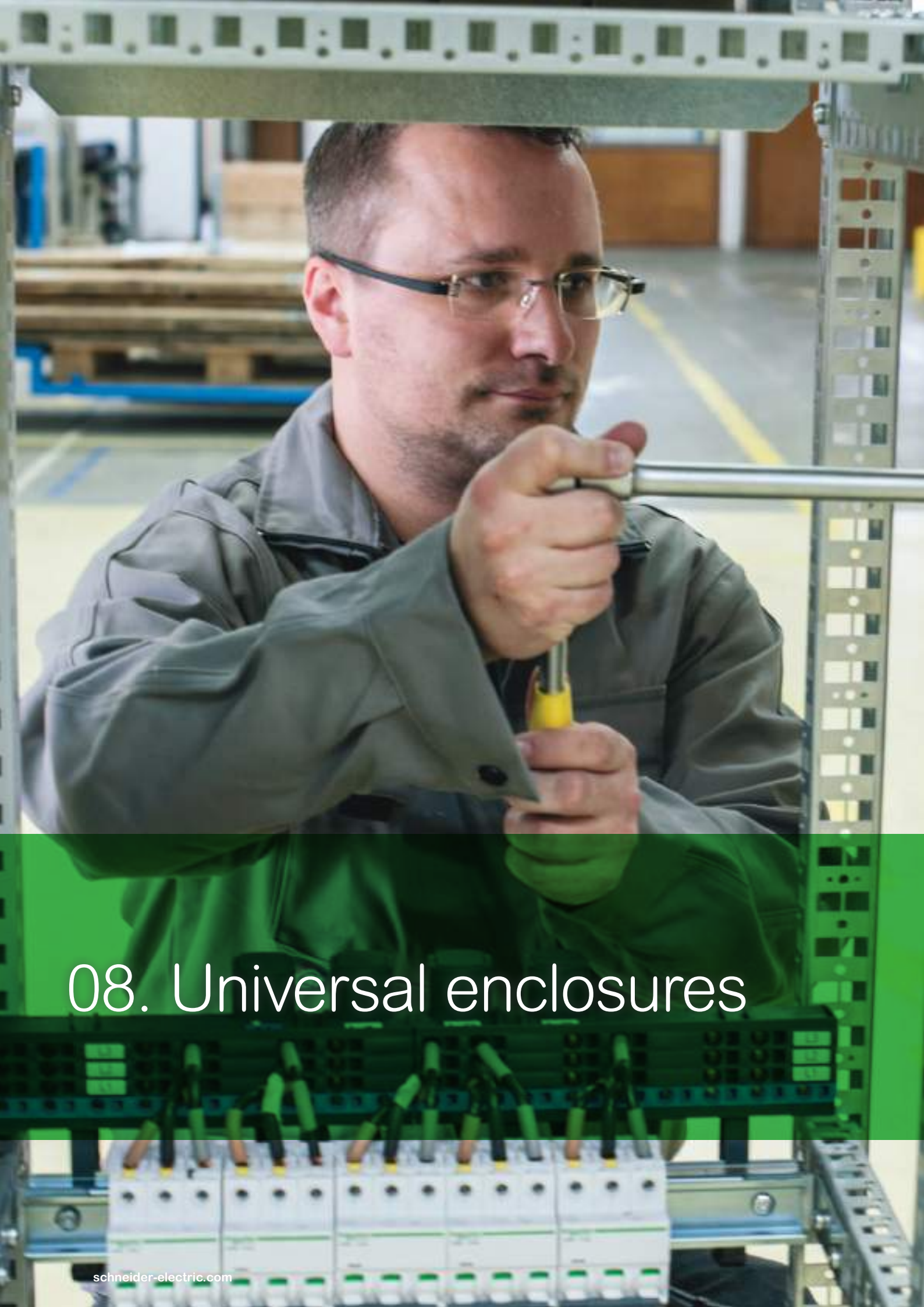

08. Universal enclosures

Spacial SDB, SBM, and SBX steel industrial boxes



Spacial SDB steel industrial boxes

Degree of protection: IP55. Mechanical protection: IK07. Finish: painted with textured epoxy-polyester resin in RAL7035 light gray

Type of box				Metal junction boxes	
				Without knock-outs	With knock-outs
Type of cover				Low cover	
Reference according to dimensions (H x W x D) in mm	85	85	49	NSYDBN88	NSYDBN88M
	105	105	49	NSYDBN1010	NSYDBN1010M
	155	105	61	NSYDBN1510	NSYDBN1510M
	206	156	83	NSYDBN2015	NSYDBN2015M
	256	206	93	NSYDBN2520	–
	307	257	116	NSYDBN3025	–



Spacial SBM steel industrial boxes

Degree of protection: IP66. Mechanical protection IK10. Finish: painted with textured epoxy-polyester resin in RAL7035 light gray

Type of box				Steel industrial boxes	
				Flat boxes	
Reference according to dimensions (H x W x D) in mm	150	150	80	NSYSBM15158	
	150	150	120	NSYSBM151512	
	150	200	80	NSYSBM15208	
	150	200	120	NSYSBM152012	
	150	300	80	NSYSBM15308	
	150	300	120	NSYSBM153012	
	150	400	80	NSYSBM15408	
	150	400	120	NSYSBM154012	
	200	200	80	NSYSBM20208	
	200	200	120	NSYSBM202012	
	200	300	80	NSYSBM20308	
	200	300	120	NSYSBM203012	
	200	400	80	NSYSBM20408	
	200	400	120	NSYSBM204012	
	200	500	80	NSYSBM20508	
	200	500	120	NSYSBM205012	
	200	600	80	NSYSBM20608	
	200	600	120	NSYSBM206012	
	200	800	120	NSYSBM208012	
	300	300	120	NSYSBM303012	
	300	400	120	NSYSBM304012	
	300	500	120	NSYSBM305012	
	300	600	120	NSYSBM306012	
	300	800	120	NSYSBM308012	
400	400	120	NSYSBM404012		
400	500	120	NSYSBM405012		
400	600	120	NSYSBM406012		
400	800	120	NSYSBM408012		



Spacial SBX stainless steel industrial boxes

Degree of protection: IP66, stainless steel AISI 304L

Type of box				Stainless steel industrial boxes	
Reference according to dimensions (H x W x D) in mm	150	150	80	NSYSBX15158	
	150	300	80	NSYSBX15308	
	200	200	80	NSYSBX20208	
	200	300	80	NSYSBX20308	
	200	400	120	NSYSBX204012	
	300	300	120	NSYSBX303012	

Spacial CRN and Spacial S3D steel wall-mounting enclosures



Spacial CRN and Spacial S3D (1) multi-purpose steel wall-mounting enclosures (2)

Degree of protection: IP66. Mechanical protection: IK10P. Finish: painted with textured epoxy-polyester resin in RAL70P35 light gray

Range				Spacial CRN	Spacial S3D
Composition				Plain door with plain mounting plate	
Reference according to dimensions (H x W x D) in mm	250	200	150	NSYCRN252150P	–
	300	200	150	–	NSYS3D3215P
	300	250	150	NSYCRN325150P	NSYS3D32515P
	300	250	200	NSYCRN325200P	–
	300	300	150	NSYCRN33150P	NSYS3D3315P
	300	300	200	NSYCRN33200P	NSYS3D3320P
	300	400	150	–	NSYS3D3415P
	300	400	200	–	NSYS3D3420P
	400	300	150	NSYCRN43150P	NSYS3D4315P
	400	300	200	NSYCRN43200P	NSYS3D4320P
	400	400	200	NSYCRN44200P	NSYS3D4420P
	400	600	200	–	NSYS3D4620P
	400	600	250	NSYCRN46250P	NSYS3D4625P
	400	600	300	NSYCRN46300P	–
	500	300	200	–	NSYS3D5320P
	500	400	150	NSYCRN54150P	–
	500	400	200	NSYCRN54200P	NSYS3D5420P
	500	400	250	NSYCRN54250P	NSYS3D5425P
	500	500	200	–	NSYS3D5520P
	500	500	250	NSYCRN55250P	NSYS3D5525P
	600	400	150	NSYCRN64150P	–
	600	400	200	NSYCRN64200P	NSYS3D6420P
	600	400	250	NSYCRN64250P	NSYS3D6425P
	600	500	150	NSYCRN65150P	–
	600	500	200	NSYCRN65200P	–
	600	500	250	NSYCRN65250P	NSYS3D6525P
	600	600	200	–	NSYS3D6620P
	600	600	250	NSYCRN66250P	NSYS3D6625P
	600	600	300	NSYCRN66300P	NSYS3D6630P
	600	600	400	–	NSYS3D6640P
600	800	300	–	NSYS3D6830P	
700	500	200	NSYCRN75200P	–	
700	500	250	NSYCRN75250P	NSYS3D7525P	
800	600	200	NSYCRN86200P	NSYS3D8620P	
800	600	250	NSYCRN86250P	NSYS3D8625P	
800	600	300	NSYCRN86300P	NSYS3D8630P	
800	600	400	–	NSYS3D8640P	
800	800	200	NSYCRN88200P	–	
800	800	250	–	NSYS3D8825P	
800	800	300	NSYCRN88300P	NSYS3D8830P	
800	1000	300	–	NSYS3D81030P	
1000	600	250	NSYCRN106250P	NSYS3D10625P	
1000	600	300	NSYCRN106300P	NSYS3D10630P	
1000	600	400	–	NSYS3D10640P	
1000	800	250	NSYCRN108250P	NSYS3D10825P	
1000	800	300	NSYCRN108300P	NSYS3D10830P	
1000	800	400	–	NSYS3D10840P	
1000	1000	300	–	NSYS3D101030P	

(1) Multi-purpose enclosures are empty enclosures meeting the majority of application requirements. The Spacial S3D offer also comprises enclosures for specific applications, including electromagnetic compatibility (EMC), Voice/Data/Image (VDI), human-machine interface (HMI), modular distribution, outdoor installation, and hazardous environments (ATEX, seismic, or nuclear). In order to check the availability of this range in your country, please contact your local Schneider Electric representative.

(2) For other versions without mounting plate, with glazed door (IK08) or double door (IP55), see the Enclosures catalog on our website www.se.com/enclosures. In order to check the availability of this range in your country, please contact your local Schneider Electric representative.

Thalassa insulating industrial boxes and wall-mounting enclosures



Thalassa TBS - TBP insulating industrial boxes

Degree of protection: IP66. Mechanical protection: IK07 (ABS boxes) and IK08 (PC boxes). Color: RAL7035 light gray

Material				ABS		PC	
Type of cover				Opaque cover	Transparent cover	Opaque cover	Transparent cover
Reference according to dimensions (H x W x D) in mm	74	74	54	NSYTBS775	–	NSYTBP775	–
	89	89	54	NSYTBS885	–	NSYTBP885	–
	116	74	62	NSYTBS1176	–	NSYTBP1176	–
	116	116	62	NSYTBS11116	–	NSYTBP11116	–
	138	93	72	NSYTBS1397	NSYTBS1397T	NSYTBP1397	NSYTBP1397T
	164	121	87	NSYTBS16128	NSYTBS16128T	NSYTBP16128	NSYTBP16128T
	192	121	87	NSYTBS19128	NSYTBS19128T	NSYTBP19128	NSYTBP19128T
	192	164	87	NSYTBS19168	NSYTBS19168T	NSYTBP19168	NSYTBP19168T
	241	194	87	NSYTBS24198	NSYTBS24198T	NSYTBP24198	NSYTBP24198T
	241	194	107	NSYTBS241910	NSYTBS241910T	NSYTBP241910	NSYTBP241910T
	291	241	88	NSYTBS29248	NSYTBS29248T	NSYTBP29248	NSYTBP29248T
	291	241	128	NSYTBS292412	NSYTBS292412T	NSYTBP292412	NSYTBP292412T
	341	291	128	NSYTBS342912	NSYTBS342912T	NSYTBP342912	NSYTBP342912T



Thalassa PLS polyester industrial boxes

Degree of protection: IP66. Mechanical protection: IK09. Color: RAL7035 light gray

Material				Polyester		
Type of cover				Transparent PC cover	Opaque PC cover	Opaque polyester cover
Reference according to dimensions (H x W x D) in mm	180	270	180	NSYPLS1827G	NSYPLSC1827G	NSYPLSP1827G
	270	270	180	NSYPLS2727G	NSYPLSC2727G	NSYPLSP2727G
	270	270	230	NSYPLS2727AG	NSYPLSC2727AG	–
	270	360	180	NSYPLS2736G	NSYPLSC2736G	NSYPLSP2736G
	270	360	230	NSYPLS2736AG	NSYPLSC2736AG	–
	270	540	180	NSYPLS2754G	NSYPLSC2754G	NSYPLSP2754G
	270	540	230	NSYPLS2754AG	NSYPLSC2754AG	–
	360	360	180	NSYPLS3636G	NSYPLSC3636G	NSYPLSP3636G
	360	540	180	NSYPLS3654G	NSYPLSC3654G	NSYPLSP3654G
	360	540	230	NSYPLS3654AG	NSYPLSC3654AG	–
	360	720	230	NSYPLS3672AG	NSYPLSC3672AG	–
	540	540	180	NSYPLS5454G	NSYPLSC5454G	NSYPLSP5454G
	540	540	230	NSYPLS5454AG	NSYPLSC5454AG	–
	540	720	230	NSYPLS5472AG	NSYPLSC5472AG	–



Thalassa PLM polyester wall-mounting enclosures

Degree of protection: IP66. Mechanical protection: IK10 (IK08 for transparent doors). Color: RAL7035 light gray

Material				ABS/PC		Polyester			
Type of door				Plain door	Transparent (IK08)	Plain door	Transparent (IK08)	Plain door with 3-point closure	Transparent (IK08) with 3-point closure
Reference according to dimensions (H x W x D) in mm	310	215	160	NSYPLM32G	NSYPLM32TG	–	–	–	–
	308	255	160	–	–	NSYPLM3025G	NSYPLM3025TG	–	–
	430	330	200	–	–	NSYPLM43G	NSYPLM43TG	NSYPLM43VG	NSYPLM43TVG
	530	430	200	–	–	NSYPLM54G	NSYPLM54TG	NSYPLM54VG	NSYPLM54TVG
	647	436	250	–	–	NSYPLM64G	NSYPLM64TG	NSYPLM64VG	NSYPLM64TVG
	747	536	300	–	–	NSYPLM75G	NSYPLM75TG	NSYPLM75VG	NSYPLM75TVG
	847	636	300	–	–	NSYPLM86G	NSYPLM86TG	NSYPLM86VG	NSYPLM86TVG
	1056	852	350	–	–	NSYPLM108G	NSYPLM108TG	–	–

Lighting accessories and ClimaSys ventilation systems

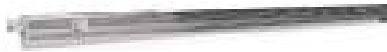

LED lamps

Type of lamp	Cost-effective LED lamps			Portable LED lamps
Voltage (V)	120/230 AC		24/48 DC	120/230 AC
Frequency (Hz)	50 - 60		–	50 - 60
Power (W)	5	10	5	10
Power factor	0.8	0.9	1	0.5
Lumens (lm)	500	1100	470	1100
Reference	NSYLAMT5LD1	NSYLAMT5LD2	NSYLAMT5LD1VDC	NSYLAMPORTL D



Type of lamp	Multi-fixing LED lamps and power cables							
Voltage (V)	120/230 AC		120 AC		24/48 DC		230 AC	
Frequency (Hz)	50 - 60							
Power (W)	10							
Lumens (lm)	640							
Standards	IEC			UL	IEC/UL			
Type of socket	SCHUKO	UTE	BRITISH	USA	Without socket			
Reference	LED lamps	NSYLAMLDS	NSYLAMLDF	NSYLAMLDB	NSYLAMLDU	NSYLAML D	NSYLAML D VDC	NSYLAML D D with presence detector
	Power cables	IEC	NSYLAM3M (1)		–	NSYLAM3M (1)	NSYLAM3MDC	NSYLAM3M (1)
		UL	–		NSYLAM3MUL (1)	NSYLAM3MUL (1)	NSYLAM3MDCUL	NSYLAM3MUL (1)
	Inter-connection cables	IEC	NSYLAM1M (1)		–	NSYLAM1M (1)	NSYLAM1MDC	NSYLAM1M (1)
		UL	–		NSYLAM1MUL (1)	NSYLAM1MUL (1)	NSYLAM1MDCUL	NSYLAM1MUL (1)

(1) For orange cables, add N to the end of the reference (example: NSYLAM3MN)



ClimaSys CV ventilation systems

Degree of protection: IP54

Color: RAL 7035 light gray

Fan flow (m³/h) (2)	Voltage (V)	Fan reference	Outlet grid reference
38	115	NSYCVF38M115PF	NSYCAG92LPF
	230	NSYCVF38M230PF	NSYCAG92LPF
85	115	NSYCVF85M115PF	NSYCAG125LPF
	230	NSYCVF85M230PF	NSYCAG125LPF
165	115	NSYCVF165M115PF	NSYCAG223LPF
	230	NSYCVF165M230PF	NSYCAG223LPF
300	115	NSYCVF300M115PF	NSYCAG223LPF
	230	NSYCVF300M230PF	NSYCAG223LPF
560	115	NSYCVF560M115PF	NSYCAG291LPF
	230	NSYCVF560M230PF	NSYCAG291LPF
850	115	NSYCVF850M115PF	NSYCAG291LPF
	230	NSYCVF850M230PF	NSYCAG291LPF
	400	NSYCVF850M400PF	NSYCAG291LPF

ClimaSys CV smart ventilation systems (1)

Degree of protection: IP54

Color: RAL 9005 semi-transparent black

Fan flow (m³/h) (2)	Voltage (V)	Smart fan reference (3)	Smart grid reference (4)
34	115	NSYCVF38M115DG	NSYCAG92DG
	230	NSYCVF38M230DG	NSYCAG92DG
74	115	NSYCVF85M115DG	NSYCAG125DG
	230	NSYCVF85M230DG	NSYCAG125DG
142	115	NSYCVF165M115DG	NSYCAG223DG
	230	NSYCVF165M230DG	NSYCAG223DG
259	115	NSYCVF300M115DG	NSYCAG223DG
	230	NSYCVF300M230DG	NSYCAG223DG
502	115	NSYCVF560M115DG	NSYCAG291DG
	230	NSYCVF560M230DG	NSYCAG291DG
731	115	NSYCVF850M115DG	NSYCAG291DG
	230	NSYCVF850M230DG	NSYCAG291DG
	400	NSYCVF850M400DG	NSYCAG291DG

(1) Smart fan has to be connected to a controller to relay information and alarms (see table below).

(2) Free flow rate at 50 Hz

(3) Supply of **NSYCV●●●DG** fan includes: 1 fan sensor (rpm&Tor measurement), 1 dirt filter sensor

(4) Supply of **NSYCAG●●●DG** grid includes: 1 dirt filter sensor



ClimaSys smart ventilation controllers

Voltage (V)	Filterstat controller reference	Thermal hub reference
30 VAC/VDC	NSYCCOFST30V	NSYCCOFSEM8U1
90-250 VAC	NSYCCOFST90250V	NSYCCOFSEM8U2
No. of ports	4	8

Filterstat communication cable

Black unshielded cable with 2 connectors at each end (material: PVC)	Cable references
Length (mm)	
500	NSYCCA50MFST
1000	NSYCCA100MFST
1500	NSYCCA150MFST
2000	NSYCCA200MFST
3000	NSYCCA300MFST
4000	NSYCCA400MFST
5000	NSYCCA500MFST

ClimaSys thermal management systems



1 ClimaSys CC mechanical thermostats

Type of control	Control of a resistance heater or alarm		Control of a fan or alarm	
Setting range	0...+60 °C	+32...+140 °F	0...+60 °C	+32...+140 °F
Reference	NSYCCOTHC	NSYCCOTHCF	NSYCCOTHO	NSYCCOTHOF

2 ClimaSys CR insulated resistance heaters, 2 poles

Power (W)	10		20	
Voltage (V)	110-250 AC	12-24 DC	110-250 AC	12-24 DC
Reference	NSYCR10WU2C	NSYCR10WU1C	NSYCR20WU2C	NSYCR20WU1C

3 ClimaSys CR aluminum resistance heaters

Power cord				
Power (W)	10		20	
Voltage (V)	12-24 DC	110-250 AC	12-24 DC	110-250 AC
Reference	NSYCR10WU1	NSYCR10WU2	NSYCR20WU1	NSYCR20WU2
Terminal block				
Power (W)	20	55	55	55
Voltage (V)	270-420 AC	12-24 DC	110-250 AC	270-420 AC
Reference	NSYCR20WU3	NSYCR55WU1	NSYCR55WU2	NSYCR55WU3

4 ClimaSys CRS ultra-thin resistance heaters

Power (W)	10		25		50	
Voltage (V)	120 AC	240 AC	120 AC	240 AC	120 AC	240 AC
Inrush current (A)	0.08	0.04	0.21	0.10	0.42	0.21
Height (mm)	130	130	130	130	200	200
Width (mm)	250	250	250	250	320	320
Depth (mm)	1.6	1.6	1.6	1.6	1.6	1.6
Reference	NSYCRS10W120V	NSYCRS10W240V	NSYCRS25W120V	NSYCRS25W240V	NSYCRS50W120V	NSYCRS50W240V

5 ClimaSys DT data loggers

Characteristics	DTT
Type of recorder	Temperature recorder
Composition	1
Reference	NSYDTEF32T

Digital Offer

ProClima

Find the best thermal solution for your enclosure
Select and calculate your thermal management requirements, according to the environment and the electrical/electronic devices installed inside the enclosure.



Digital Rules

Find the accessories that suit your enclosure
The digital rules allow you to select the best components from the current product range. There will be no risk of mistake, since product and accessory selection take place automatically, saving you time and money.



Note: For more detailed information on our products, see the Enclosures catalog on our website www.se.com/enclosures.



09. Telemecanique Sensors - Detection components

Telemecanique Sensors

Simply easy!™

Founded over 90 years ago, **Telemecanique Sensors** is specialized in sensors and sensor-related technology.

As a **global leader** in the sensors business, we help our customers select the right technology to get the best performance and reliability from their machines.



Focused on 3 core values – **Simplicity, Proximity and Expertise** – we have become experts in factory automation sensors as well as specialists in demanding applications, making our customers' lives "Simply easy!"

Visit our website and discover our full offer on www.tesensors.com

Telemecanique
Sensors
SPOTLIGHT: Wireless

Limit switches: XC Wireless

Choose :

1

>

2

>

3

>

4

>

Reference

XCMW

Snap Action

One way pulsed wireless transmission

Metal Roller Plunger

XCMW102

Metal End Plunger

XCMW110

Plastic Roller Lever

XCMW115

Metal Roller Lever

XCMW116

Adjustable Length Plastic Roller Lever

XCMW145

Receivers

Choose :

1

>

2

>

3

>

Reference

ZBRR

32 Transmitters

4xPNP

ZBRRC

2xRelays

ZBRRD

XZBW

2 Transmitters

2 x PNP (Q1 & Q2)

XZBWR2STT24

NO

2-way continuous Wireless transmission

XZBWE112A24

Radio transmitter

Connects to any sensor or switch!

Pressure switches: XM Range

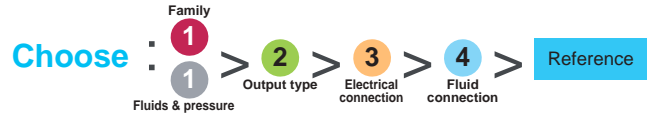

XMLA / XMLB Electromechanical		Hydraulic oils, air, fresh water, sea water / Temp. : up to 70° C							
Screw terminal		1 C/O single pole contact fixed differential			1 C/O single pole contact adjustable differential				
		Bar	psi	ISO M20	Pg13	DIN connector	ISO M20	Pg13	DIN connector
		-1	-14.5	XMLAM01V2S12	XMLAM01V2S11	XMLAM01V2C11	XMLBM02V2S12	XMLBM02V2S11	XMLBM02V2C11
		2.5	36.3	XMLA002A2S12	XMLA002A2S11	XMLA002A2C11	XMLB002A2S12	XMLB002A2S11	XMLB002A2C11
		4	58	XMLA004A2S12	XMLA004A2S11	XMLA004A2C11	XMLB004A2S12	XMLB004A2S11	XMLB004A2C11
		10	145	XMLA010A2S12	XMLA010A2S11	XMLA010A2C11	XMLB010A2S12	XMLB010A2S11	XMLB010A2C11
		20	290	XMLA020A2S12	XMLA020A2S11	XMLA020A2C11	XMLB020A2S12	XMLB020A2S11	XMLB020A2C11
		35	508	XMLA035A2S12	XMLA035A2S11	XMLA035A2C11	XMLB035A2S12	XMLB035A2S11	XMLB035A2C11
		Hydraulic oils / Temp. : up to 160° C							
		1	14.5	XMLA001R2S12	XMLA001R2S11	XMLA001R2C11	XMLB001R2S12	XMLB001R2S11	XMLB001R2C11
		70	1015	XMLA070D2S12	XMLA070D2S11	XMLA070D2C11	XMLB070D2S12	XMLB070D2S11	XMLB070D2C11
		160	2320	XMLA160D2S12	XMLA160D2S11	XMLA160D2C11	XMLB160D2S12	XMLB160D2S11	XMLB160D2C11
		300	4350	XMLA300D2S12	XMLA300D2S11	XMLA300D2C11	XMLB300D2S12	XMLB300D2S11	XMLB300D2C11
	G 1/4 (female)	500	7250	XMLA500D2S12	XMLA500D2S11	XMLA500D2C11	XMLB500D2S12	XMLB500D2S11	XMLB500D2C11

XMLR Electronic + Display		Hydraulic oils, air, fresh water, refrigerant fluids							
M12 4 pin or 5 pin		-20... +80° C		Analog output		Analog + 2 switching outputs			
		Bar	psi	4...20 mA	0...10 V	PNP - NO/NC programmable			
		-1	-14.5	XMLRM01G0T25	XMLRM01G0T75	XMLRM01G2P25			
		1	14.5	XMLR001G0T25	XMLR001G0T75	XMLR010G2P25			
		2.5	35.2	XMLR2D5G0T25	XMLR2D5G0T75	XMLR016G2P25			
		10	145	XMLR010G0T25	XMLR010G0T75	XMLR040G2P25			
		16	232	XMLR016G0T25	XMLR016G0T75				
		25	362	XMLR025G0T25	XMLR025G0T75				
		40	580	XMLR040G0T25	XMLR040G0T75				
		100	1450	XMLR100M0T25	XMLR100M0T75				
		160	2320	XMLR160M0T25	XMLR160M0T75				
		250	3625	XMLR250M0T25	XMLR250M0T75	XMLR250M2P25			
		400	5800	XMLR400M0T25	XMLR400M0T75	XMLR400M2P25			
	600	8700	XMLR600M0T25	XMLR600M0T75					
		Hydraulic oils, air, fresh water, refrigerant fluids							
		-20... +80° C		Analog + switching output		2 switching outputs			
				PNP - NO/NC programmable		PNP - NO/NC programmable			
		Bar	psi	4...20 mA	0...10 V				
		-1	-14.5	XMLRM01G1P25	XMLRM01G1P75	XMLRM01G2P05			
		1	14.5	XMLR001G1P25	XMLR001G1P75	XMLR001G2P05			
		2.5	35.2	XMLR2D5G1P25	XMLR2D5G1P75	XMLR2D5G2P05			
		10	145	XMLR010G1P25	XMLR010G1P75	XMLR010G2P05			
		16	232	XMLR016G1P25	XMLR016G1P75	XMLR016G2P05			
		25	362	XMLR025G1P25	XMLR025G1P75	XMLR025G2P05			
		40	580	XMLR040G1P25	XMLR040G1P75	XMLR040G2P05			
		100	1450	XMLR100M1P25	XMLR100M1P75	XMLR100M2P05			
		160	2320	XMLR160M1P25	XMLR160M1P75	XMLR160M2P05			
		250	3625	XMLR250M1P25	XMLR250M1P75	XMLR250M2P05			
		400	5800	XMLR400M1P25	XMLR400M1P75	XMLR400M2P05			
		600	8700	XMLR600M1P25	XMLR600M1P75	XMLR600M2P05			
	G 1/4A (female)								

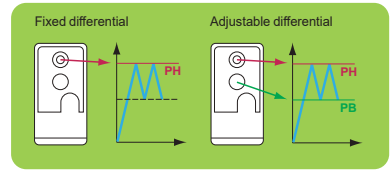

9

Cabling XM

Connectors (female)			PUR pre wired connectors (female) (3)				PUR Jumper cables					
M12	straight	elbowed	M12	straight	elbowed	elbowed PNP LED	M12 (female)	straight	elbowed			
(1)	4 pin	XZCC12FDM40B	XZCC12FCM40B	4 pin	2 m	XZCP1141L2	XZCP1241L2	XZCP1340L2	M12 (male)	straight	straight	
(2)	4 pin	XZCC12FDP40B	XZCC12FCP40B		5 m	XZCP1141L5	XZCP1241L5	XZCP1340L5	4 pin	1 m	XZCR1511041C1	XZCR1512041C1
(1)	5 pin	XZCC12FDM50B	XZCC12FCM50B		10 m	XZCP1141L10	XZCP1241L10	XZCP1340L10		2 m	XZCR1511041C2	XZCR1512041C2

(1) Steel ring (2) Plastic ring

(3) For a PVC cable, add the letter V after the P. Example: XZCPxxxxx become XZCPVxxxxx

Pressure switches: XM Range

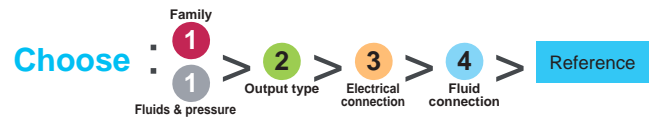

XMLP Electronic transmitter		Hydraulic oils, air, fresh water					
M12 4 pin (male)		-30...+85° C					
		Analog output					
				4...20 mA	0...10 V	0.5...4.5 V	
Bar	psi						
-1	-14.5	XMLPM00GD21F					
1	14.5	XMLP001GD21F					
6	87	XMLP006GD21F					
10	145	XMLP010BD21F					
16	232	XMLP016BD21F					
25	362	XMLP025BD21F					
40	580	XMLP040BD21F					
60	870	XMLP060BD21F					
100	1450	XMLP100BD21F					
160	2320	XMLP160BD21F					
250	3625	XMLP250BD21F					
400	5800	XMLP400BD21F					
600	8700	XMLP600BD21F					

ZMLP Display and switch		4-20 mA analog + switching output		2 switching outputs	
M12 4 pin (male)		NO/NC Programmable		NO/NC Programmable	
PNP		Window	Hysteresis	Fixed hysteresis	
		ZMLPA1P2SW	ZMLPA1P2SH	ZMLPA2P0SH	

Only usable with 4-20mA analog output XMLP electronic transmitter

Quick mounting bracket		Horizontal plan	Vertical plan or pipe
		XMLPZLH01	XMLPZLV01

Cabling XM			Connectors (female)			PUR pre wired connectors (female) (3)			PUR Jumper cables				
M12	straight	elbowed	M12	straight	elbowed	elbowed PNP LED	M12 (female)	straight	elbowed	M12 (male)	straight	elbowed	
(1)	4 pin	XZCC12FDM40B	XZCC12FCM40B	4 pin	2 m	XZCP1141L2	XZCP1241L2	XZCP1340L2		4 pin	1 m	XZCR1511041C1	XZCR1512041C1
(2)	4 pin	XZCC12FDP40B	XZCC12FCP40B		5 m	XZCP1141L5	XZCP1241L5	XZCP1340L5			2 m	XZCR1511041C2	XZCR1512041C2
(1)	5 pin	XZCC12FDM50B	XZCC12FCM50B		10 m	XZCP1141L10	XZCP1241L10	XZCP1340L10					

(1) Steel ring (2) Plastic ring (3) For a PVC cable, add the letter V after the P. Example: XZCPxxxxx become XZCPVxxxxx

Limit switches: XC Range

See Page 60897/1 for
XC Wireless SPOTLIGHT!

Choose: **1** > **2** > **3** > **4** > Reference
Body Head Contact Connection

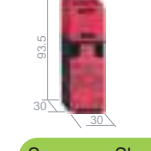
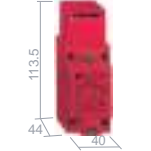
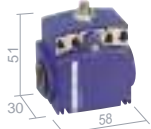

XCKD Metal	NO+NC Snap	M16	XCKD2110P16	XCKD2102P16	XCKD2121P16	XCKD2106P16	XCKD2118P16	XCKD2145P16
		Pg11	XCKD2110G11	XCKD2102G11	XCKD2121G11	XCKD2106G11	XCKD2118G11	XCKD2145G11
		M12 5P	XCKD2110M12	XCKD2102M12	XCKD2121M12	XCKD2106M12	XCKD2118M12	XCKD2145M12

XCKP Plastic	NO+NC Snap	M16	XCKP2110P16	XCKP2102P16	XCKP2121P16	XCKP2106P16	XCKP2118P16	XCKP2145P16
		Pg11	XCKP2110G11	XCKP2102G11	XCKP2121G11	XCKP2106G11	XCKP2118G11	XCKP2145G11
		M12 4P	XCKP2110M12	XCKP2102M12	XCKP2121M12	XCKP2106M12	XCKP2118M12	XCKP2145M12

XCKT Plastic	NO+NC Snap	M16	XCKT2110P16	XCKT2102P16	XCKT2121P16	XCKT2106P16	XCKT2118P16	XCKT2145P16
		Pg11	XCKT2110G11	XCKT2102G11	XCKT2121G11	XCKT2106G11	XCKT2118G11	XCKT2145G11

XCMD Metal	NO+NC Snap	1 m	XCMD2110L1	XCMD2102L1	XCMD2124L1	XCMD21F0L1	XCMD21F2L1	XCMD2115L1	XCMD2116L1
	NO+NC Slow	1 m	XCMD2510L1	XCMD2502L1	XCMD2524L1	XCMD25F0L1	XCMD25F2L1	XCMD2515L1	XCMD2516L1
	NO+NC Snap	M12 5P	XCMD2110C12	XCMD2102C12	XCMD2124C12	XCMD21F0C12	XCMD21F2C12	XCMD2115C12	XCMD2116C12
	1 C/O Snap	M12 4P	XCMD2110M12	XCMD2102M12	XCMD2124M12	XCMD21F0M12	XCMD21F2M12	XCMD2115M12	XCMD2116M12

XCKM Metal	NO+NC Snap	M20	XCKM110H29	XCKM102H29	XCKM121H29	XCKM115H29	XCKM106H29
		Pg11	XCKM110	XCKM102	XCKM121	XCKM115	XCKM106

XCKL Metal	NO+NC Snap	CG	XCKL110	XCKL102	XCKL121	XCKL115	XCKL106
-----------------------------	------------	----	---------	---------	---------	---------	---------

XCKJ Metal	NO+NC Snap	M20	XCKJ161H29	XCKJ167H29	XCKJ10511H29	XCKJ10513H29	XCKJ10541H29	XCKJ10559H29
		Pg13	XCKJ161	XCKJ167	XCKJ10511	XCKJ10513	XCKJ10541	XCKJ10559
		1/2NPT	XCKJ161H7	XCKJ167H7	XCKJ10511H7	XCKJ10513H7	XCKJ10541H7	XCKJ10559H7
		M12 5P	XCKJ161D	XCKJ167D	XCKJ10511D	XCKJ10513D	XCKJ10541D	XCKJ10559D

(1) Plastic roller (2) Steel roller

XCSA Metal		M20	NC+2NO Slow	2NC+NO Slow	3NC Slow	Accessories	
		Pg13	XCSA502	XCSA702	XCSA802	XCSZ01	XCSZ03
		1/2NPT	XCSA503	XCSA703	XCSA803		

XCSA Plastic		M16	NC+NO Slow	2NC Slow	2NO+NC Slow	2NC+NO Slow	2NC+NO Snap	Accessories	
		Pg11	XCSA592	XCSA792	XCSA892	XCSA992	XCSA492	XCSZ11	XCSZ13
		1/2NPT	XCSA593	XCSA793	XCSA893	XCSA993	XCSA493		

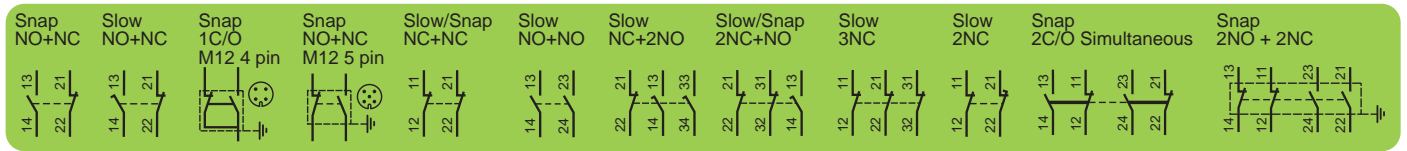

- M16 Tapped M16x1.5 for ISO cable gland
- M20 Tapped M20x1.5 for ISO cable gland
- Pg11 Tapped for a N°11 cable gland
- Pg13 Tapped for a N°13 cable gland
- 1/2NPT Tapped for a 1/2" NPT
- PF1/2 Tapped for a PF1/2"
- M12 5P Connector M12, 5 pin
- M12 4P Connector M12, 4 pin
- CG Tapped with cable gland included

Cabling XC

M12	PUR pre wired connectors (female) (1)			Connectors (female)			
		straight	elbowed	elbowed PNP LED	M12	straight	elbowed
4 pin	2 m	XZCP1141L2	XZCP1241L2	XZCP1340L2	(2) 4 pin	XZCC12FDM40B	XZCC12FCM40B
	5 m	XZCP1141L5	XZCP1241L5	XZCP1340L5	(3) 4 pin	XZCC12FDP40B	XZCC12FCP40B
	10 m	XZCP1141L10	XZCP1241L10	XZCP1340L10	(2) 5 pin	XZCC12FDM50B	XZCC12FCM50B
5 pin	5 m	XZCP1164L5	XZCP1264L5				

(2) Steel ring (3) Plastic ring

(1) For a PVC cable, add the letter V after the P. Example: XZCPxxxxx become XZCPVxxxxx

Limit switches: XC Range

XCKP / XCKD / XCKT

Plastic / Metal / Plastic

ZCE10	ZCE11	ZCE02	ZCE21	ZCE06	ZCE08	ZCE01	ZCY18	ZCY45	ZCY49	ZCY39
NO+NC Snap						NO+NC Snap		NO+NC Snap		
NO+2NC Snap						NO+NC Snap		NC+NC Snap		
NO+NC Slow						NO+NC Snap		NO+NC Slow		
NC+NC Slow						NO+NC Snap		NC+NC Snap		
NC+NC Snap						NO+NC Snap		NO+NO Slow		
NO+NO Slow						NO+NC Snap		XCKT NC+NC Snap		
XCKP	ZCP21	ZCP39	ZCP25	ZCP27	ZCP29	ZCP28	M12 4P	ZC21M12	M16	ZCT21P16
XCKD	ZCD21	ZCD39	ZCD25	ZCD27	ZCD29	ZCD28	M12 5P	ZCD21M12	Pg11	ZCT21G11
								NO+NC Slow		
								M16		
								Pg11		
								ZCT25P16		
								ZCT25G11		

Cable entry	M16	M20	Pg11	Pg13.5	1/2 NPT	PF1/2
XCKP	ZCPEP16	ZCPEP20	ZCPEG11	ZCPEG13	ZCPEN12	ZCPEF12
XCKD	ZCDEP16	ZCDEP20	ZCDEG11	ZCDEG13	ZCDEN12	ZCDEF12

XCMD

Metal

ZCEF2	ZCEF0	ZCE24	ZCE10	ZCE11	ZCE02	ZCE21	ZCE06	ZCE08	ZCE01	ZCY15	ZCY16
NO+NC Snap		NO+NC Slow				2NO+2NC Snap		NO+NC Snap		1C/O Snap	
ZCMD21		ZCMD25				ZCMD4D		ZCMD21C12		ZCMD21M12	
+		+				+					
1 m	ZCMC21L1	ZCMD21L1	ZCMC25L1	ZCMD25L1	ZCMC4DL1	ZCMD41L1	M12 5P	ZCMD21C12	M12 4P	ZCMD21M12	
2 m	ZCMC21L2	ZCMD21L2	ZCMC25L2	ZCMD25L2	ZCMC4DL2	ZCMD41L2					
5 m	ZCMC21L5	ZCMD21L5	ZCMC25L5	ZCMD25L5	ZCMC4DL5	ZCMD41L5					

XCKM / XCKL

Metal

ZCKD15	ZCKD16	ZCKD06	ZCKD08	ZCKD21	ZCKD23
ZCKD10	ZCKD02	ZCKD05	ZCKY41	ZCKY43	ZCKY59
NO+NC Snap		NO+NC Slow			
3xPg11	ZCKM1	ZCKM5			
3xM20	ZCKM1H29	ZCKM5H29			
PE		ZCKL1	ZCKL5		
1/2 NPT		ZCKL1H7	ZCKL5H7		

XCKS	NO+NC Snap	NO+NC Slow	
Pg13	ZCKS1	ZCKS5	
M20	ZCKS1H29	ZCKS5H29	

XCKJ	NO+NC Snap	NO+NC Slow	2C/O Simult. Snap
Pg13	ZCKJ1	ZCKJ5	ZCKJ2
M20	ZCKJ1H29	ZCKJ5H29	ZCKJ2H29
1/2 NPT	ZCKJ1H7	ZCKJ5H7	ZCKJ2H7
M12 5P	ZCKJ1D	ZCKJ5D	-

XCKJ

Metal

ZCKE23	ZCKE67	ZCKE61	ZCKE06	ZCKE08
ZCKY11	ZCKY13	Ø plastic	Ø steel	Ø steel
ZCKY41	ZCKY43	ZCKY59	ZCKY51	ZCKY53

XCKS

Plastic

ZCKD01	ZCKD02		
ZCKD05	ZCKY31	ZCKY39	ZCKY41

Inductives: XS Range

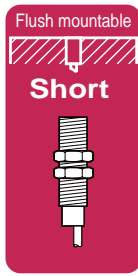

			M8		M12	
Sensing distance			1.5 mm	2.5 mm	2 mm	4 mm
DC3	PNP	cable	XS508B1PAL2	XS108B3PAL2	XS512B1PAL2	XS112B3PAL2
		connector	XS508B1PAM8	XS108B3PAM8	XS512B1PAM12	XS112B3PAM12
	NPN	cable	XS508B1NAL2	XS108B3NAL2	XS512B1NAL2	XS112B3NAL2
		connector	XS508B1NAM8	XS108B3NAM8	XS512B1NAM12	XS112B3NAM12
DC2		cable	XS508BSCAL2	XS608B3CAL2	XS512BSDAL2	XS612B3DAL2
		connector	XS508BSCAL01M12	XS608B3CAL01M12	XS512BSDAM12	XS612B3DAM12
DC3	PNP	cable	XS508BLPAL2	XS608B1PAL2	XS512BLPAL2	XS612B1PAL2
		connector	XS508BLPAM12	XS608B1PAM12	XS512BLPAM12	XS612B1PAM12
	NPN	cable	XS508BLNAL2	XS608B1NAL2	XS512BLNAL2	XS612B1NAL2
		connector	XS508BLNAM12	XS608B1NAM12	XS512BLNAM12	XS612B1NAM12
DC2		cable	XS508B1DAL2	XS608B1DAL2	XS512B1DAL2	XS612B1DAL2
		connector	XS508B1DAM12	XS608B1DAM12	XS512B1DAM12	XS612B1DAM12
AC/DC		cable			XS512B1MAL2	XS612B1MAL2
		connector			XS512B1MAU20	XS612B1MAU20
Output function		NO		A		A
		NC		B		B
		NO + NC				(short only) C

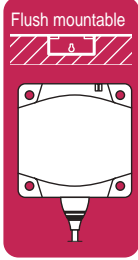
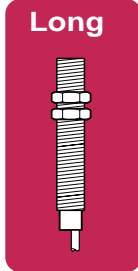

			∅ 8x22x8 mm	∅ 15x32x8 mm	∅ 26x26x13 mm	∅ 40x40x15 mm
Sensing distance			2.5 mm	5 mm	10 mm	15 mm
DC3	PNP	cable	XS7J1A1PAL2	XS7F1A1PAL2	XS7E1A1PAL2	XS7C1A1PAL2
		connector	XS7J1A1PAL01M8	XS7F1A1PAL01M8	XS7E1A1PAM8	XS7C1A1PAM8
	NPN	cable	XS7J1A1NAL2	XS7F1A1NAL2	XS7E1A1NAL2	XS7C1A1NAL2
		connector	XS7J1A1NAL01M8	XS7F1A1NAL01M8	XS7E1A1NAM8	XS7C1A1NAM8
DC2		cable	XS7J1A1DAL2	XS7F1A1DAL2	XS7E1A1DAL2	XS7C1A1DAL2
		connector	XS7J1A1DAL01M8	XS7F1A1DAL01M8	XS7E1A1DAM8	XS7C1A1DAM8

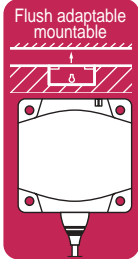

			∅ 26x26x13 mm		∅ 40x40x15 mm	
Sensing distance			15 mm	25 mm		
DC3	PNP	cable			XS8E1A1PAL2	XS8C1A1PAL2
		connector			XS8E1A1PAM8	XS8C1A1PAM8
	NPN	cable			XS8E1A1NAL2	XS8C1A1NAL2
		connector			XS8E1A1NAM8	XS8C1A1NAM8
AC/DC		cable			XS8E1A1MAL2	XS8C1A1MAL2
		connector			XS8E1A1MAL01U20	XS8C1A1MAL01U20
Output function		NO		A		A
		NC		B		B

9

XS●●●●●●M8:
Connector M8 3 pin

XS●●●●●●M12:
Connector M12 4 pin

XS●●●●●●U20:
Connector 1/2" 3 pin

Cabling XS

		PUR pre wired connectors (female) (1)	
		straight	elbowed
M8	3 pin	2 m XZCP0566L2	XZCP0666L2
		5 m XZCP0566L5	XZCP0666L5
		10 m XZCP0566L10	XZCP0666L10
1/2"	3 pin	5 m XZCP1865L5	XZCP1965L5

(1) For a PVC cable, add the letter V after the P. Example: XZCPxxxxxx become XZCPVxxxxxx

Inductives: XS Range

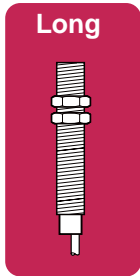
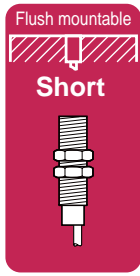

			M18		M30	
Sensing distance			5 mm	8 mm	10 mm	15 mm
DC3	PNP	cable	XS518B1PAL2	XS118B3PAL2	XS530B1PAL2	XS130B3PAL2
		connector	XS518B1PAM12	XS118B3PAM12	XS530B1PAM12	XS130B3PAM12
	NPN	cable	XS518B1NAL2	XS118B3NAL2	XS530B1NAL2	XS130B3NAL2
		connector	XS518B1NAM12	XS118B3NAM12	XS530B1NAM12	XS130B3NAM12
DC2	cable	XS518BSDAL2	XS618B3DAL2	XS530BSDAL2	XS630B3DAL2	
	connector	XS518BSDAM12	XS618B3DAM12	XS530BSDAM12	XS630B3DAM12	
DC3	PNP	cable	XS518BLPAL2	XS618B1PAL2	XS530BLPAL2	XS630B1PAL2
		connector	XS518BLPAM12	XS618B1PAM12	XS530BLPAM12	XS630B1PAM12
	NPN	cable	XS518BLNAL2	XS618B1NAL2	XS530BLNAL2	XS630B1NAL2
		connector	XS518BLNAM12	XS618B1NAM12	XS530BLNAM12	XS630B1NAM12
DC2	cable	XS518B1DAL2	XS618B1DAL2	XS530B1DAL2	XS630B1DAL2	
	connector	XS518B1DAM12	XS618B1DAM12	XS530B1DAM12	XS630B1DAM12	
AC/DC	cable	XS518B1MAL2	XS618B1MAL2	XS530B1MAL2	XS630B1MAL2	
	connector	XS518B1MAU20	XS618B1MAU20	XS530B1MAU20	XS630B1MAU20	
Output function	NO		A		A	A
	NC		B		B	B
	NO + NC		(short only) C		(short only) C	(short only) C

Accessories

M8	XSZB108
M12	XSZB112
M18	XSZB118
M30	XSZB130

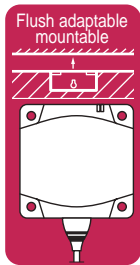
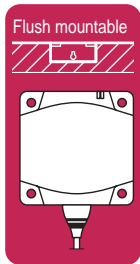
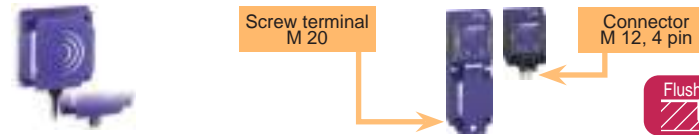

			80x80x26 mm
Sensing distance			40 mm
DC3	PNP	cable	XS7D1A1PAL2
		connector	XS7D1A1PAM12
	NPN	cable	XS7D1A1NAL2
		connector	XS7D1A1NAM12
DC2	cable	XS7D1A1DAL2	
	connector	XS7D1A1DAM12	
DC3	PNP	cable	XS8D1A1PAL2
		connector	XS8D1A1PAM12
	NPN	cable	XS8D1A1NAL2
		connector	XS8D1A1NAM12
AC/DC	cable	XS8D1A1MAL2	
	connector	XS8D1A1MAU20	
Output function	NO		A
	NC		B

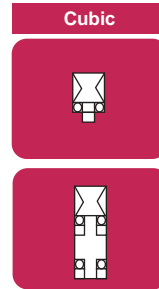

			40x40x117 mm	20 mm	40 mm
Sensing distance					
DC4	PNP	NO+NC	XS8C2A1PCM12	XS8C2A4PCM12	
		NO+NC	XS8C2A1NCM12	XS8C2A4NCM12	
	NPN	NO	XS8C2A1DAM12	XS8C2A4DAM12	
		NO	XS8C2A1MAU20	XS8C2A4MAU20	
DC4	PNP	NO+NC	XS8C4A1PCP20	XS8C4A4PCP20	
		NO+NC	XS8C4A1NCP20	XS8C4A4NCP20	
	NPN	NO or NC	XS8C4A1DPP20	XS8C4A4DPP20	
		NO or NC	XS8C4A1MPP20	XS8C4A4MPP20	
Select the type of connection	M20		P20	P20	
	PG13		G13	G13	
	1/2" NPT		N12	N12	

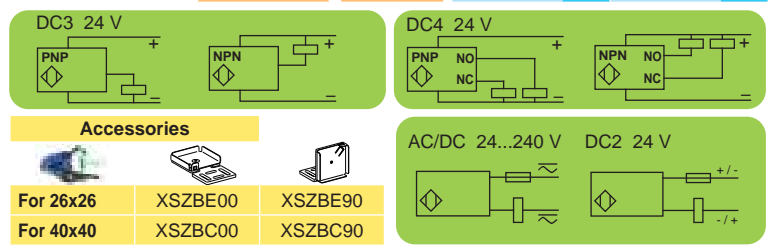

Rotation monitoring: XSAV Range

Choose: **1** Speed > **2** Output Type > Reference

			Low Speed		High Speed	
Sensing distance			10 mm	10 mm		
M30	Flush	cable	Output type	DC3-PNP	XSAV11373	XSAV12373
				AC/DC	XSAV11801	XSAV12801

Cabling XS

		PUR pre wired connectors (female) (1)		
M12		straight	elbowed	elbowed PNP LED
4 pin	2 m	XZCP1141L2	XZCP1241L2	XZCP1340L2
	5 m	XZCP1141L5	XZCP1241L5	XZCP1340L5
	10 m	XZCP1141L10	XZCP1241L10	XZCP1340L10

		Connectors (female)	
M12		straight	elbowed
4 pin	(2)	XZCC12FDM40B	XZCC12FCM40B
4 pin	(3)	XZCC12FDP40B	XZCC12FCP40B

(1) For a PVC cable, add the letter V after the P. Example: XZCPxxxxxx become XZCPVxxxxxx

(2) Steel ring (3) Plastic ring

Ultrasonics: XX Range

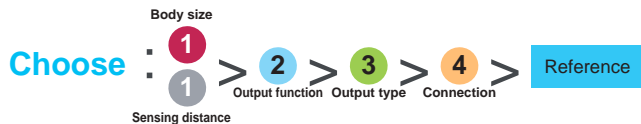

			M12		M18		M18 plastic (2)	M18 brass (2)	M18 stainless (2)	M18 metal
Sensing distance			0.05 m	0.1 m	0.15 m	0.5 m Adjust. (1)	1 m Adjust. (1)	1 m Adjust. (1)	1 m Adjust. (1)	0.05 m
Connectors/Cables			M8 4 pin	M8 3 pin	M12 4 pin	M12 4 pin	M12 5 pin	M12 5 pin	M12 5 pin	M12 4 pin
NO	DC4	PNP/NPN	XX512A1KAM8		XX518A1KAM12					
	DC3	PNP		XX512A2PAM8		XX518A3PAM12				XXV18B1PAM12
		NPN		XX512A2NAM8		XX518A3NAM12				XXV18B1NAM12
NO or NC	DC3	PNP					XXS18P1PM12	XXS18B1PM12	XXS18S1PM12	
							XXA18P1PM12	XXA18B1PM12	XXA18S1PM12	
Analog		4...20 mA				XX918A3C2M12	XXS18P1AM12	XXS18B1AM12	XXS18S1AM12	
							XXA18P1AM12	XXA18B1AM12	XXA18S1AM12	
		0...10 V				XX918A3F1M12	XXS18P1VM12	XXS18B1VM12	XXS18S1VM12	
							XXA18P1VM12	XXA18B1VM12	XXA18S1VM12	

(1) Adjustable with XXZPB100

(2) Configurable with XXZBOX01 by software

S = straight A = angled



			M30 plastic (2)				M30 Brass (2)			M30 Stainless (2)		
Sensing distance			1 m Adjust. (1)	2 m Adjust. (1)	4 m Adjust. (1)	8 m Adjust. (3)	1 m Adjust. (1)	2 m Adjust. (1)	4 m Adjust. (1)	1 m Adjust. (1)	2 m Adjust. (1)	4 m Adjust. (1)
Connectors			M12 5-pin	M12 5-pin	M12 5-pin	M12 5-pin	M12 5-pin	M12 5-pin	M12 5-pin	M12 5-pin	M12 5-pin	M12 5-pin
NO or NC	DC3	PNP	XXS30P1PM12	XXS30P2PM12	XXS30P4PM12		XXS30B1PM12	XXS30B2PM12	XXS30B4PM12	XXS30S1PM12	XXS30S2PM12	XXS30S4PM12
			XXA30P1PM12	XXA30P2PM12			XXA30B1PM12	XXA30B2PM12		XXA30S1PM12	XXA30S2PM12	
	DC4	2 x PNP				XXS30P8PPM12						
			2 x NPN				XXS30P8NPM12					
Analog	DC3	4...20mA	XXS30P1AM12	XXS30P2AM12	XXS30P4AM12		XXS30B1AM12	XXS30B2AM12	XXS30B4AM12	XXS30S1AM12	XXS30S2AM12	XXS30S4AM12
			XXA30P1AM12	XXA30P2AM12			XXA30B1AM12	XXA30B2AM12		XXA30S1AM12	XXA30S2AM12	
	DC3	0...10V	XXS30P1VM12	XXS30P2VM12	XXS30P4VM12		XXS30B1VM12	XXS30B2VM12	XXS30B4VM12	XXS30S1VM12	XXS30S2VM12	XXS30S4VM12
							XXA30B1VM12	XXA30B2VM12		XXA30S1VM12	XXA30S2VM12	
Analog + NO or NC	DC4	4...20 mA + PNP				XXS30P8APM12						
						XXS30P8VPM12						
		0...10V + PNP										

(1) Adjustable with XXZPB100

(2) Configurable with XXZBOX01 by software

(3) Push-button integrated on the product

S = straight A = angled



			Flat 7.6x19x33		Flat 16x30x74	Flat 60x30x18 + M18	
Sensing distance			0.1 m		0.25 m	0.5 m Adjust.	0.5 m Adjust.
Connectors			M12 4 pin		M12 4 pin	M12 4 pin	M12 4 pin
NO	DC3	PNP	XX7F1A2PAL01M12	XX7K1A2PAM12			XX7V1A1PAM12 (1)
			XX7F1A2NAL01M12	XX7K1A2NAM12			XX7V1A1NAM12 (1)
Analog		4...20 mA					XX9V1A1C2M12 (1)
			0...10 V				XX9V1A1F1M12 (1)

(1) Adjustable with XXZPB100

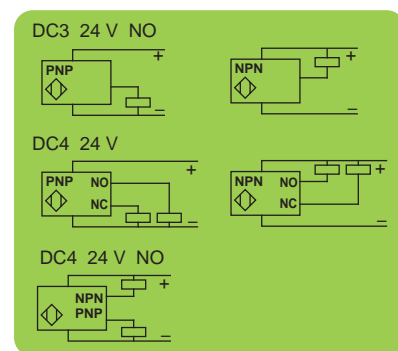

9

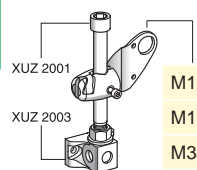

M12	XUZB2012
M18	XUZB2003
M30	XUZB2030

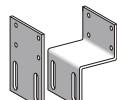

For XX7K

Flat	XXZ3074F
Cranked	XXZ3074S



M12	XXZ12
M18	XUZA118
M30	XXZ30
XX7F	XXZ1933

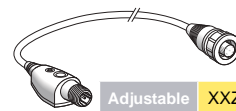

Adjustable XXZPB100

Photo-electrics: XU Range



		Sensing distance			M18 metal	M18 plastic
	0.6 m	DC3	PNP	cable	XUB5BPANL2	XUB5APANL2
				connector 4P	XUB5BPANM12	XUB5APANM12
	0.1 m	DC3	PNP	cable	XUB5BNANL2	XUB5ANANL2
				connector 4P	XUB5BNANM12	XUB5ANANM12
			NPN	cable	XUB4BPANL2	XUB4APANL2
				connector 4P	XUB4BPANM12	XUB4APANM12
NPN	cable	XUB4BNANL2	XUB4ANANL2			
	connector 4P	XUB4BNANM12	XUB4ANANM12			

Miniature	
1.9 m	XUM5APXBL2
	XUM5APXBM8
	XUM5ANXBL2
1.1 m	XUM5ANXBM8
	XUM6APXBL2
	XUM6APXBM8
0.25 m	XUM6ANXBL2
	XUM6ANXBM8
	XUM4APXBL2
0.3 m	XUM4ANXBL2
	XUM4ANXBM8
	XUM8APXBL2
8 m	XUM8APXBM8
	XUM8ANXBL2
	XUM8ANXBM8

Background Suppression



Polarized Reflex	2 m	DC3	PNP	cable	XUB9BPANL2	XUB9APANL2
			PNP	connector 4P	XUB9BPANM12	XUB9APANM12
				NPN	cable	XUB9BNANL2
			NPN	connector 4P	XUB9BNANM12	XUB9ANANM12
				Accessory: Reflector		XUZC50

Reflex	4 m	DC3	PNP	cable	XUB1BPANL2	XUB1APANL2
			PNP	connector 4P	XUB1BPANM12	XUB1APANM12
				NPN	cable	XUB1BNANL2
			NPN	connector 4P	XUB1BNANM12	XUB1ANANM12
				Accessory: Reflector		XUZC50

Thru-beam	15 m	DC3	PNP	cable	XUB2BPANL2R	XUB2APANL2R
			PNP	connector 4P	XUB2BPANM12R	XUB2APANM12R
				NPN	cable	XUB2BNANL2R
			NPN	connector 4P	XUB2BNANM12R	XUB2ANANM12R
				Transmitter	cable	XUB2BKSNL2T
			Output function	connector 4P	XUB2BKSNM12T	XUB2AKSNM12T
				NO	A	A
NC	B	B				

30 m	XUM2APXBL2
	XUM2APXBM8
	XUM2ANXBL2
	XUM2ANXBM8
Transmitters are already included	

Multimode	DC3	PNP	cable	XUB0BPSNL2	XUB0APSNL2	XUM0APXBL2		
		PNP	connector 4P	XUB0BPSNM12	XUB0APSNM12	XUM0APXBM8		
			NPN	cable	XUB0BNSNL2	XUB0ANSNL2	XUM0ANSAL2	
		NPN	connector 4P	XUB0BNSNM12	XUB0ANSNM12	XUM0ANSAM8		
			Sensing distance		Background Sup: 0.12 m	Diffuse: 0.3 m	BGS: 0.1 m	D: 0.4 m
		Output function		NO or NC	Polarized reflex: 3 m	Thru-beam: 20 m	P: 3 m	TB: 10 m
		Transmitter	DC	cable	XUB0BKSNL2T	XUB0AKSNL2T	XUM0AKSAL2T	
connector 4P	XUB0BKSNM12T			XUB0AKSNM12T	XUM0AKSAM8T			

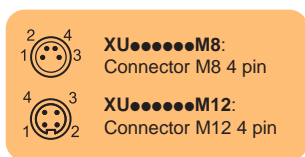

Cabling XU

		PUR pre wired connectors (female) (1)	
M8		straight	elbowed
4 pin	2 m	XZCP0941L2	XZCP1041L2
	5 m	XZCP0941L5	XZCP1041L5
	10 m	XZCP0941L10	XZCP1041L10

Reflectors

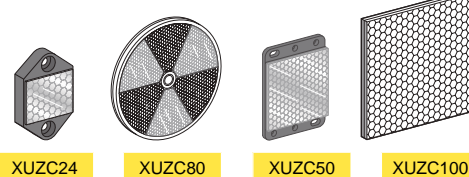

(1) For a PVC cable, add the letter V after the P. Example: XZCPxxxxx become XZCPVxxxxx

Photo-electrics: XU Range

		Sensing distance			Compact 50x50 mm		Compact 92x71 mm										
	Diffuse	1 m	DC3	PNP	cable	XUK5APANL2	2.1 m	DC3	PNP	terminals	XUX5APANT16						
				connector 4P	XUK5APANM12	connector 4P			XUX5APANM12								
			NPN	cable	XUK5ANANL2	NPN		terminals	XUX5ANANT16								
				connector 4P	XUK5ANANM12			connector 4P	XUX5ANANM12								
			AC/DC	Relay	cable	XUK5ARCNL2		AC/DC	Relay	terminals	XUX5ARCNT16						
Output function		NO		A		A											
		NC		B		B											
	Polarized Reflex	5 m	DC3	PNP	cable	XUK9APANL2	11 m	DC3	PNP	terminals	XUX9APANT16						
				connector 4P	XUK9APANM12	connector 4P			XUX9APANM12								
			NPN	cable	XUK9ANANL2	NPN		terminals	XUX9ANANT16								
				connector 4P	XUK9ANANM12			connector 4P	XUX9ANANM12								
			AC/DC	Relay	cable	XUK9ARCNL2		AC/DC	Relay	terminals	XUX9ARCNT16						
Accessory: Reflector				XUZC50		XUZC50											
	Reflex	7 m	DC3	PNP	cable	XUK1APANL2	14 m	DC3	PNP	terminals	XUX1APANT16						
				connector 4P	XUK1APANM12	connector 4P			XUX1APANM12								
			NPN	cable	XUK1ANANL2	NPN		terminals	XUX1ANANT16								
				connector 4P	XUK1ANANM12			connector 4P	XUX1ANANM12								
			AC/DC	Relay	cable	XUK1ARCNL2		AC/DC	Relay	terminals	XUX1ARCNT16						
Accessory: Reflector				XUZC50		XUZC50											
	Thru-beam	30 m	DC3	PNP	cable	XUK2APANL2R	40 m	DC3	PNP	terminals	XUX2APANT16R						
				connector 4P	XUK2APANM12R	connector 4P			XUX2APANM12R								
			NPN	cable	XUK2ANANL2R	NPN		terminals	XUX2ANANT16R								
				connector 4P	XUK2ANANM12R			connector 4P	XUX2ANANM12R								
			Accessory: Transmitter		cable			XUK2AKSNL2T		terminals		XUX0AKSAT16T					
		connector 4P		XUK2AKSNM12T		connector 4P		XUX0AKSAM12T									
		AC/DC		Relay		cable		XUK2ARCNL2R		AC/DC		Relay		terminals		XUX2ARCNT16R	
				cable		XUK2ARCNL2T				terminals		XUX0ARCTT16T					

Multimode		DC3 PNP/NPN		cable		XUK0AKSAL2		DC3 PNP/NPN		terminals		XUX0AKSAT16		
	Background suppression (BGS)	Diffuse (D)	AC/DC	Relay	cable	XUK0ARCTL2	AC/DC	Relay	terminals	XUX0ARCTT16	Background Suppression: 0.28 m		Diffuse: 0.8 m	
											Polarized reflex: 4 m		Thru-beam: 30 m	
											Accessory: Transmitter		DC	
				connector 4P		XUK0AKSAM12T		connector 4P		XUX0AKSAM12T				
				AC/DC		cable		AC/DC		terminals		XUX0ARCTT16T		

Other fixings

Single bracket

	standard	with ball joint
XUB	XUZA118 (stainless steel)	XUZA218 (plastic)
XUM	XUZA50	-
XUK	XUZA51	-
XUX	XUXZ2000	-

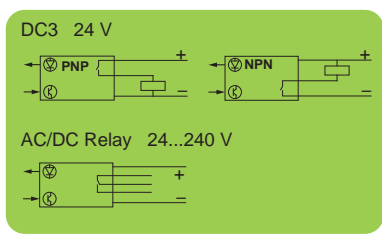

PUR pre wired connectors (female) (1)				Connectors (female)				
M12		straight	elbowed	elbowed PNP LED	M12	straight	elbowed	
4 pin	2 m	XZCP1141L2	XZCP1241L2	XZCP1340L2	4 pin (2)	XZCC12FDM40B	XZCC12FCM40B	
	5 m	XZCP1141L5	XZCP1241L5	XZCP1340L5		4 pin (3)	XZCC12FDP40B	XZCC12FCP40B
	10 m	XZCP1141L10	XZCP1241L10	XZCP1340L10				

(1) For a PVC cable, add the letter V after the P. Example: XZCPxxxxx become XZCPVxxxxx

(2) Steel ring (3) Plastic ring

Forks: XUV Range

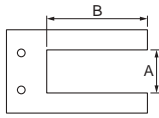

			A: 50 mm / B: 60 mm	A: 80 mm / B: 60 mm	A: 120 mm / B: 120 mm	A: 180 mm / B: 120 mm
DC3	PNP	M8 3 pin	XUVR0605PANM8	XUVR0608PANM8	XUVR1212PANM8	XUVR1218PANM8
	NPN	M8 3 pin	XUVR0605NANM8	XUVR0608NANM8	XUVR1212NANM8	XUVR1218NANM8
Output function		NO		A	A	A
		NC		B	B	B

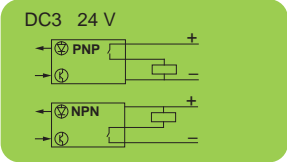

Cabling XX & XUV

		PUR pre wired connectors (female) (1)			Connectors (female)		
M8		straight	elbowed	elbowed PNP LED	M12	straight	elbowed
3 pin	2 m	XZCP0566L2	XZCP0666L2		(2) 4 pin	XZCC12FDM40B	XZCC12FCM40B
	5 m	XZCP0566L5	XZCP0666L5		(3) 4 pin	XZCC12FDP40B	XZCC12FCP40B
	10 m	XZCP0566L10	XZCP0666L10		(2) Steel ring (3) Plastic ring		
4 pin	2 m	XZCP0941L2	XZCP1041L2				
	5 m	XZCP0941L5	XZCP1041L5				
	10 m	XZCP0941L10	XZCP1041L10				
M12					Connectors (male)		
4 pin	2 m	XZCP1141L2	XZCP1241L2	XZCP1340L2	M12	straight	elbowed
	5 m	XZCP1141L5	XZCP1241L5	XZCP1340L5	4 pin	XZCC12MDM40B	XZCC12MCM40B
	10 m	XZCP1141L10	XZCP1241L10	XZCP1340L10	5 pin	XZCC12MDM50B	XZCC12MCM50B

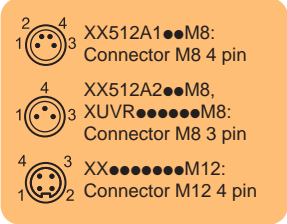

(1) For a PVC cable, add the letter V after the P. Example: XZCPxxxxx become XZCPVxxxxx

RFID Systems: XG Range



Panel mounting (1)

Compact 40x40mm		
Sensing distance 18-70mm		
PNP output with 1 pulse	Modbus RTU	
Blue body, connector on back	White body with remote lights, connector on back	Stand alone
XGCS491B201	XGCS49LB201	XGCS490B201

(1) compatible with ZB5AZ905 and XGSZCNFAC



Screw mounting

Compact 40x40mm	Compact 80x80mm	
Sensing distance 18-70mm	Sensing distance 20-100mm	
Modbus RTU		Modbus TCP & Ethernet/IP
Blue body, connector and cable by side		
XGCS4901201	XGCS8901201	XGCS850C201

Accessories	Part Number	Description
	XGSZCNFAC	Set of configuration badges
	XGSZCNF01	Configuration badge
	XGHB90E341	Pack of user's badges
	XGHBPB3345	Key fob tag

XZCC12MDB50R	M12 connector
XZCPV11V2L2/5/10	M12 pre-wired connector
XZCPV12V2L2/5/10	M12 pre-wired connector

Note: For our complete range of sensor solutions, visit www.tesensors.com

Life Is On

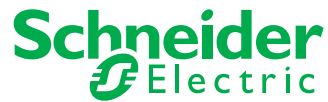

Learn more about automation and control solutions at www.se.com

The information provided in this documentation contains general descriptions and/or technical characteristics of the performance of the products contained herein. This documentation is not intended as a substitute for and is not to be used for determining suitability or reliability of these products for specific user applications. It is the duty of any such user or integrator to perform the appropriate and complete risk analysis, evaluation and testing of the products with respect to the relevant specific application or use thereof. Neither Schneider Electric nor any of its affiliates or subsidiaries shall be responsible or liable for misuse of the information contained herein.

Schneider Electric Industries SAS
35, rue Joseph Monier - CS 30323
F92506 Rueil-Malmaison Cedex